



# SNAP-IN TYPE ALUMINUM ELECTROLYTIC CAPACITORS

CAT. No. E1001G (Ver.3)

INDEX		
PRODUCT SEARCH	SERIES TABLE	➔
	GROUP CHART	➔
PRODUCTION GUIDE	PRECAUTIONS AND GUIDELINES (Aluminum Electrolytic Capacitor)	➔
	PART NUMBERING SYSTEM	➔
	ENVIRONMENTAL CONSIDERATION	➔
	PACKAGING	➔
	AVAILABLE TERMINALS FOR SNAP-IN TYPE	➔
	STANDARDIZATION	➔
	WORLD-WIDE MANUFACTURING LOCATIONS	➔
PRODUCT SPECIFICATIONS	SNAP-IN TYPE	➔
RELIABILITY DATA		➔
APPENDIX (GLOBAL CODE)		➔

Series		Features	Endurance (+R=With ripple)	Standard type	Low impedance	Solvent resistant	Terminal type	Rated voltage range (Vdc)	Capacitance range (μF)	
Conductive Polymer Electrolyte Type	PXF <small>(NEW!)</small>	Vertical type, super low ESR	105°C 2,000 hours		●	●	SMD	2.5 to 6.3	220 to 1,000	
	PXE <small>(Upgrade!)</small>	Vertical type, super low ESR	105°C 2,000 hours		●	●	SMD	2.5 to 16	33 to 2,700	
	PXA <small>(Upgrade!)</small>	Vertical type, super low ESR	105°C 1,000 to 2,000 hours	●	●	●	SMD	2.5 to 25	3.3 to 1,500	
	PXH	125°C Vertical type	125°C 1,000 hours		●	●	SMD	2.5 to 20	22 to 1,000	
	PSC <small>(Upgrade!)</small>	Radial lead type, super low ESR, high ripple current	105°C 2,000 hours		●	●	Radial	2.5 to 16	270 to 2,700	
	PSA	Super low ESR, high ripple current	105°C 2,000 hours		●	●	Radial	2.5 to 16	47 to 1,000	
	PS <small>(Upgrade!)</small>	Radial lead type, super low ESR	105°C 2,000 hours	●	●	●	Radial	2.5 to 35	18 to 1,500	
Surface Mount	Vertical Type	MVS	4.5mm height	85°C 2,000 hours	●	●	SMD	4 to 50	0.1 to 220	
		MVA	5.5 to 22.0mm max. height, downsized	85°C 2,000 hours			▲	SMD	4 to 450	0.1 to 10,000
		MV	5.5 to 10.5mm max. height	85°C 1,000 to 2,000 hours	●	●	●	SMD	4 to 63	0.1 to 1,000
		MVE	5.5 to 22.0mm max. height, downsized	105°C 1,000 to 2,000 hours			▲	SMD	6.3 to 450	0.47 to 6,800
		MVK	5.5 to 10.5mm max. height	105°C 1,000 to 2,000 hours	●	●	●	SMD	6.3 to 50	0.1 to 1,000
		MKA	5.5 to 10.5mm max. height	105°C 1,000 to 2,000 hours			●	SMD	6.3 to 50	0.1 to 1,000
		MZA	6.1 to 10.5mm max. height, very low impedance	105°C 2,000 hours		●	●	SMD	6.3 to 80	3.3 to 1,500
		MVY	5.5 to 22.0mm max. height	105°C 1,000 to 5,000 hours		●	▲	SMD	6.3 to 100	1.0 to 8,200
		MZD <small>(NEW!)</small>	105°C 5,000 hours, low impedance, long life	105°C 5,000 hours		●	●	SMD	6.3 to 50	10 to 470
		MLA	Low impedance, long life	105°C 3,000 hours		●	●	SMD	6.3 to 50	10 to 1,000
		MVJ	6.0mm max. height	105°C 2,000 hours			●	SMD	6.3 to 50	0.1 to 100
		MLD <small>(NEW!)</small>	105°C 5,000 hours, long life	105°C 5,000 hours			●	SMD	6.3 to 50	0.1 to 1,000
		MVL	6.0 to 10.5mm max. height	105°C 3,000 to 5,000 hours			●	SMD	6.3 to 50	0.1 to 1,000
		MVH	6.0 to 22.0mm max. height	125°C 1,000 to 5,000 hours			▲	SMD	10 to 450	3.3 to 4,700
		MHB <small>(NEW!)</small>	10.5mm max. height (Ask Engineering No767 in detail)	125°C 2,000 hours			●	SMD	10 to 35	47 to 470
		MKB <small>(NEW!)</small>	10.5mm max. height	105°C 3,000 hours			●	SMD	400	2.2 to 4.7
		MV-BP	5.5mm max. height, bi-polar	85°C 2,000 hours			●	SMD	4 to 50	0.1 to 47
MVK-BP	6.0mm max. height, bi-polar	105°C 1,000 hours			●	SMD	6.3 to 50	0.1 to 47		
Miniature	Low Profile	SRM	5mm height, downsized	85°C 1,000 hours		●	Radial	4 to 50	0.1 to 330	
		SRE	5mm height	85°C 1,000 hours	●		Radial	4 to 50	0.1 to 100	
		KRE	5mm height	105°C 1,000 hours	●	●	Radial	6.3 to 50	0.1 to 100	
		SRA	7mm height	85°C 1,000 hours	●		Radial	4 to 63	0.1 to 470	
		KMA	7mm height	105°C 1,000 hours	●	●	Radial	4 to 63	0.1 to 220	
		SRG	φ4×7 to φ18×25mm, low profile	85°C 1,000 to 2,000 hours			●	Radial	4 to 50	0.1 to 10,000
		KRG	φ4×7 to φ18×25mm, low profile	105°C 1,000 hours			●	Radial	6.3 to 50	0.1 to 10,000
	General Purpose	SMQ	Downsized	85°C 2,000 hours	●		Radial	6.3 to 450	0.1 to 47,000	
		KMQ	Downsized	105°C 1,000 to 2,000 hours +R	●	▲	Radial	6.3 to 450	0.1 to 47,000	
		SMG	General, downsized	85°C 2,000 hours	●	▲	Radial	6.3 to 450	0.1 to 39,000	
		KMG	General, downsized	105°C 1,000 to 2,000 hours +R	●	▲	Radial	6.3 to 450	0.1 to 22,000	
		SME	General (Ask Engineering Bulletin No511 in detail)	85°C 2,000 hours			▲	Radial	6.3 to 450	0.1 to 15,000
		KME	General (Ask Engineering Bulletin No512 in detail)	105°C 1,000 hours +R			▲	Radial	6.3 to 400	0.1 to 15,000
		SME-BP	Bi-polar, general	85°C 2,000 hours	●	●	Radial	6.3 to 100	0.47 to 6,800	
		KME-BP	Bi-polar, general	105°C 1,000 hours	●	●	Radial	6.3 to 100	0.47 to 6,800	
	High Frequency Use	KZM	Lowest impedance, long life	105°C 6,000 to 10,000 hours +R	●		Radial	6.3 to 50	27 to 10,000	
		KZH	Lowest impedance, long life	105°C 5,000 to 6,000 hours +R	●		Radial	6.3 to 35	47 to 8,200	
KZE		Lowest impedance, long life	105°C 1,000 to 5,000 hours +R	●		Radial	6.3 to 100	6.8 to 6,800		
KY		Low impedance, long life	105°C 4,000 to 10,000 hours +R	●		Radial	6.3 to 100	0.47 to 18,000		
LXZ		Low impedance, downsized	105°C 2,000 to 8,000 hours +R	●	●	Radial	6.3 to 63	12 to 18,000		
LXY		Low impedance, high reliability	105°C 2,000 to 8,000 hours +R	●	●	Radial	10 to 63	10 to 8,200		
LXV		Low impedance	105°C 2,000 to 5,000 hours +R		●	●	Radial	6.3 to 100	5.6 to 15,000	
KMF		Low impedance, high CV, general (Ask Engineering Bulletin No630 in detail)	105°C 2,000 hours +R		●		Radial	160 to 450	2.2 to 220	

■ : Promotional products

▲ : Some of range are solvent resistant.

Series		Features	Endurance (+R=With ripple)	Standard type	Low impedance	Solvent resistant	Terminal type	Rated voltage range (Vdc)	Capacitance range (μF)
Miniature	High Reliability	KXJ <small>(Upgrade!)</small>	Downsized, long life, for input filtering	105°C 10,000 to 12,000 hours +R	●		Radial	160 to 450	6.8 to 680
		KXG	Downsized, long life, for input filtering	105°C 8,000 to 10,000 hours +R	●		Radial	160 to 450	6.8 to 330
		KMX	Long life, for input filtering <small>(Ask Engineering Bulletin No 646 in detail)</small>	105°C 8,000 to 10,000 hours +R	●		Radial	160 to 450	3.3 to 680
		SMH	φ20×20 to φ22×50mm	85°C 2,000 hours +R	●		Radial	160 to 450	33 to 470
		KMH	φ20×20 to φ22×50mm	105°C 2,000 hours +R	●		Radial	160 to 450	33 to 470
		PAG	Low profile, for input filtering	105°C 2,000 hours +R			Radial	200 to 450	18 to 560
		KLJ	Downsized, no sparks with DC overvoltage	105°C 2,000 hours +R			Radial	200 & 400	4.7 to 330
		KLG	No sparks with DC overvoltage	105°C 2,000 hours +R			Radial	200 & 400	22 to 330
		FL	Long life	105°C 3,000 hours +R		●	Radial	6.3 to 50	0.47 to 270
		GPA	125°C, downsized, low impedance	125°C 3,000 to 5,000 hours +R	●	●	Radial	25 to 50	470 to 6,800
		GXE	125°C, downsize, low impedance	125°C 2,000 to 5,000 hours +R	●	▲	Radial	10 to 450	4.7 to 4,700
	GXL	125°C Long life	125°C 5,000 hours +R		●	Radial	10 to 50	100 to 1,000	
	Special Application	LBG	For airbag	105°C 5,000 hours +R	●	●	Radial	25 & 35	1,000 to 11,000
		KZG	For PC motherboard	105°C 2,000 hours +R	●		Radial	6.3 to 16	470 to 3,300
LLA		Low DC leakage, general	85°C 1,000 hours		●	Radial	6.3 to 50	0.1 to 15,000	
PH		For photo flash	55°C 5,000 times charging			Radial	300 & 330	—	
Large Sized	General Purpose	KMR	105°C, Snap-in terminal, super downsized	105°C 2,000 hours +R	●		Pin	160 to 450	100 to 3,900
		SMQ	Snap-in terminal, more downsized	85°C 2,000 hours +R	●		Pin	160 to 450	82 to 3,900
		KMQ	Snap-in terminal, more downsized	105°C 2,000 hours +R	●		Pin	35, 50, 160 to 450	68 to 33,000
		SMM	Snap-in terminal, downsized	85°C 3,000 hours +R	●		Pin	160 to 450	47 to 3,300
		KMS <small>(NEW!)</small>	Snap-in terminal, downsized	105°C 3,000 hours +R	●		Pin	160 to 450	82 to 3,300
		KMM	Snap-in terminal, downsized	105°C 2,000 to 3,000 hours +R	●		Pin	160 to 450	39 to 3,300
		SMH	Snap-in terminal, general <small>(Refer Engineering Bulletin No585 for 160 to 450V)</small>	85°C 2,000 hours +R	●		Pin	6.3 to 100	820 to 100,000
		KMH	Snap-in terminal, general <small>(Refer Engineering Bulletin No584 for 160 to 450V)</small>	105°C 2,000 hours +R	●		Pin	6.3 to 100	560 to 82,000
	Low Profile	SLM	15mm height	85°C 2,000 hours +R			Pin	160 to 400	47 to 560
		KLM	15mm height	105°C 2,000 hours +R			Pin	160 to 400	39 to 390
	High Reliability	LXM	Long life	105°C 7,000 hours +R			Pin	160 to 450	47 to 2,200
		LXS <small>(NEW!)</small>	Snap-in terminal downsized	105°C 5,000 hours +R	●		Pin	160 to 450	82 to 3,300
		LXQ	Long life, downsized	105°C 5,000 hours +R			Pin	160 to 450	82 to 2,700
		LXG	Long life	105°C 5,000 hours +R			Pin	10 to 100	390 to 47,000
CHA <small>(Upgrade!)</small>		No sparks with DC overvoltage, downsized	105°C 2,000 hours +R			Pin	200 to 450	56 to 1,200	
LXH		No sparks with DC overvoltage	105°C 3,000/5,000 hours +R			Pin	200 & 400	68 to 1,500	
RWE-LR	For air-conditioning <small>(Ask Engineering Bulletin No768 in detail)</small>	85°C 3,000 hours +R			Lug	250 to 450	330 to 2,200		
Screw-mount Terminal Type	General Purpose	SME	Screw terminal, general	85°C 2,000 hours +R	●		Screw	10 to 250	560 to 680,000
		KMH	Screw terminal, general	105°C 2,000 hours +R	●		Screw	10 to 400	180 to 680,000
	For Inverter	RWG	85°C, high ripple, downsized, long life	85°C 5,000 hours +R			Screw	350 to 450	1,500 to 18,000
		RWF	High ripple, long life	85°C 5,000 hours +R			Screw	350 to 450	820 to 22,000
		RWE	High ripple	85°C 2,000 hours +R	●		Screw	350 to 550	100 to 12,000
		RWY	High ripple, long life, low cost	85°C 5,000 hours +R			Screw	350 to 450	500 to 14,000
		RWL	High ripple, long life	85°C 20,000 hours +R			Screw	350 to 450	2,200 to 12,000
		FTP	Ellips can shape, high ripple	85°C 5,000 hours +R			Screw	63 to 450	270 to 21,000
		LXA	Long life	105°C 2,000/5,000 hours +R			Screw	10 to 525	330 to 390,000
		LXR	High ripple, long life	105°C 5,000 hours +R			Screw	350 to 450	2,200 to 15,000
LWY	Low cost <small>(Ask Engineering Bulletin No714 in detail)</small>	105°C 5,000 hours +R			Screw	350 to 450	460 to 13,000		

■ : Promotional products

▲ : Some of range are solvent resistant.

CONDUCTIVE POLYMER ALUMINUM SOLID CAPACITORS

◆SURFACE MOUNT

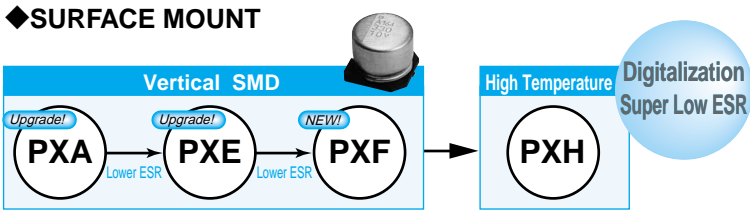

◆RADIAL LEAD

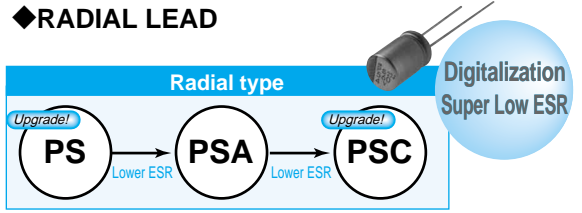

ALUMINUM ELECTROLYTIC CAPACITORS

◆SURFACE MOUNT

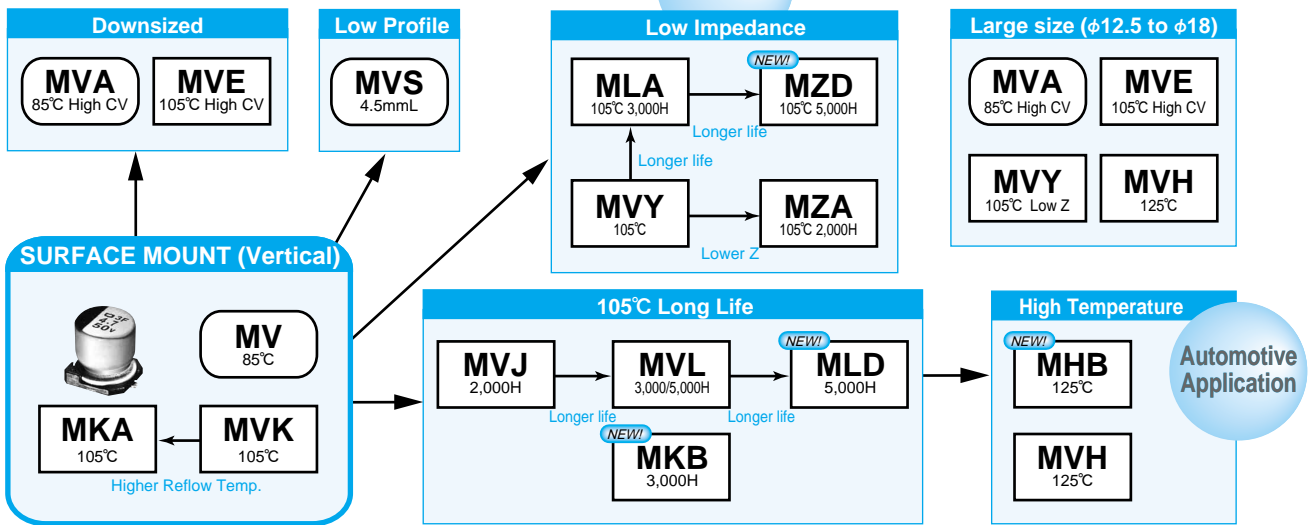

◆RADIAL LEAD

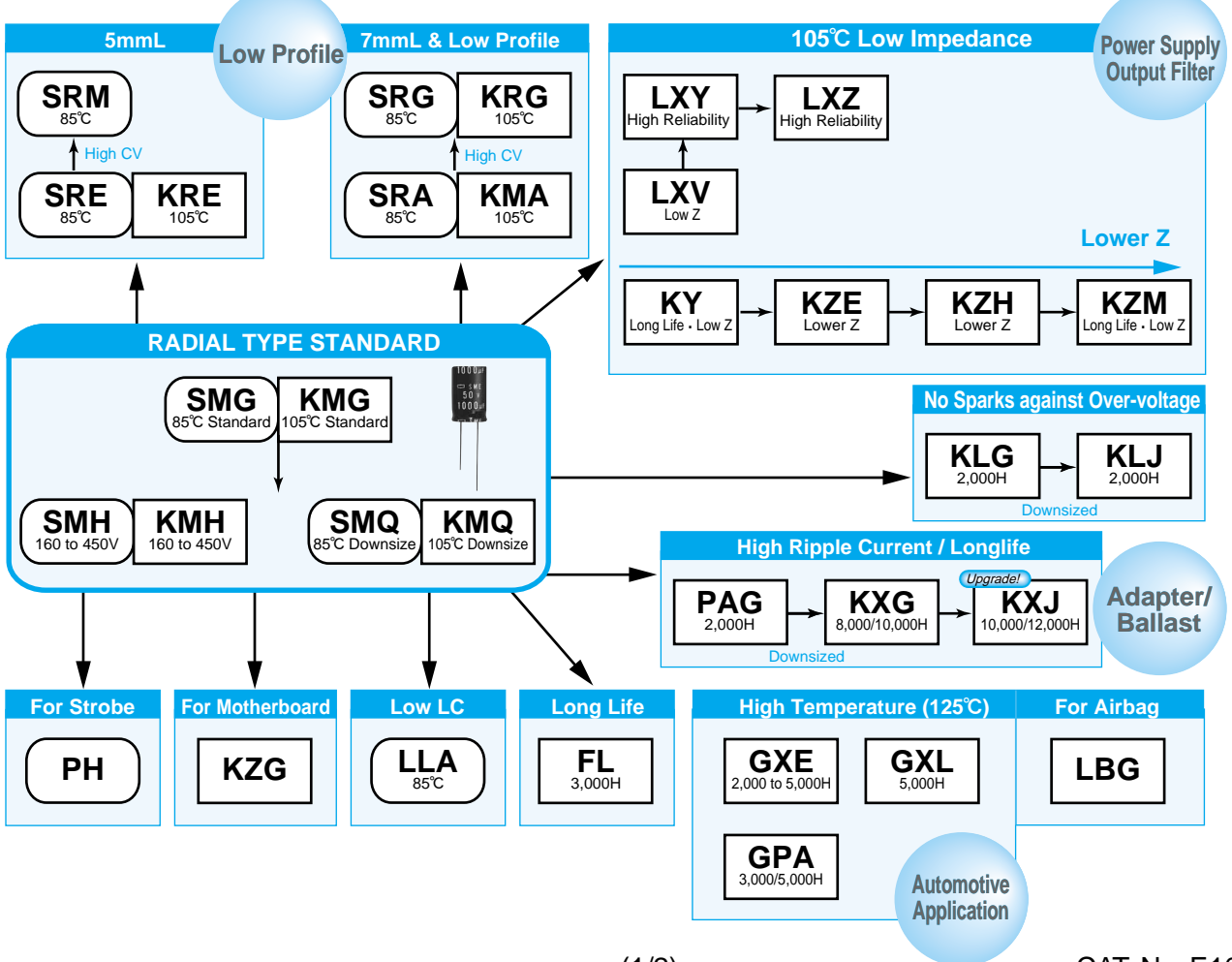

ALUMINUM ELECTROLYTIC CAPACITORS

◆SNAP-IN

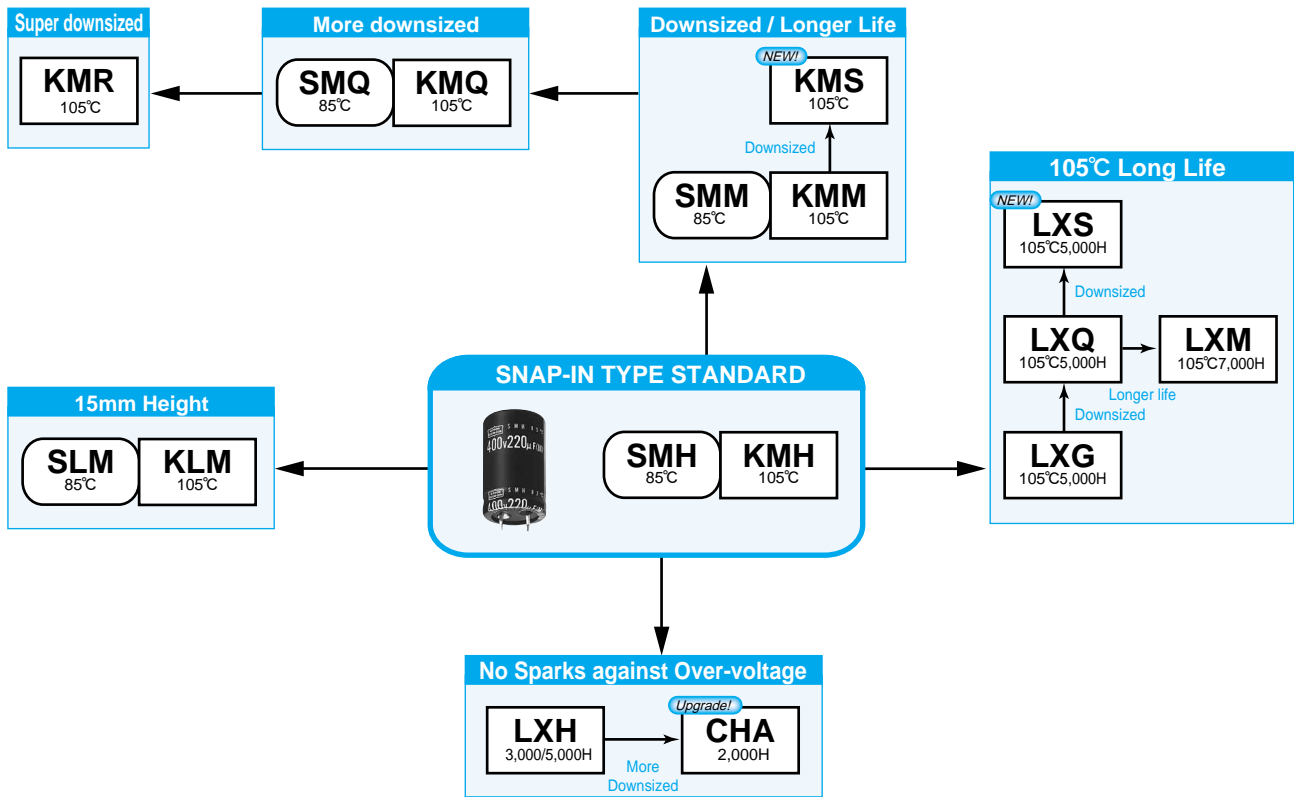

◆SCREW-MOUNT TERMINAL

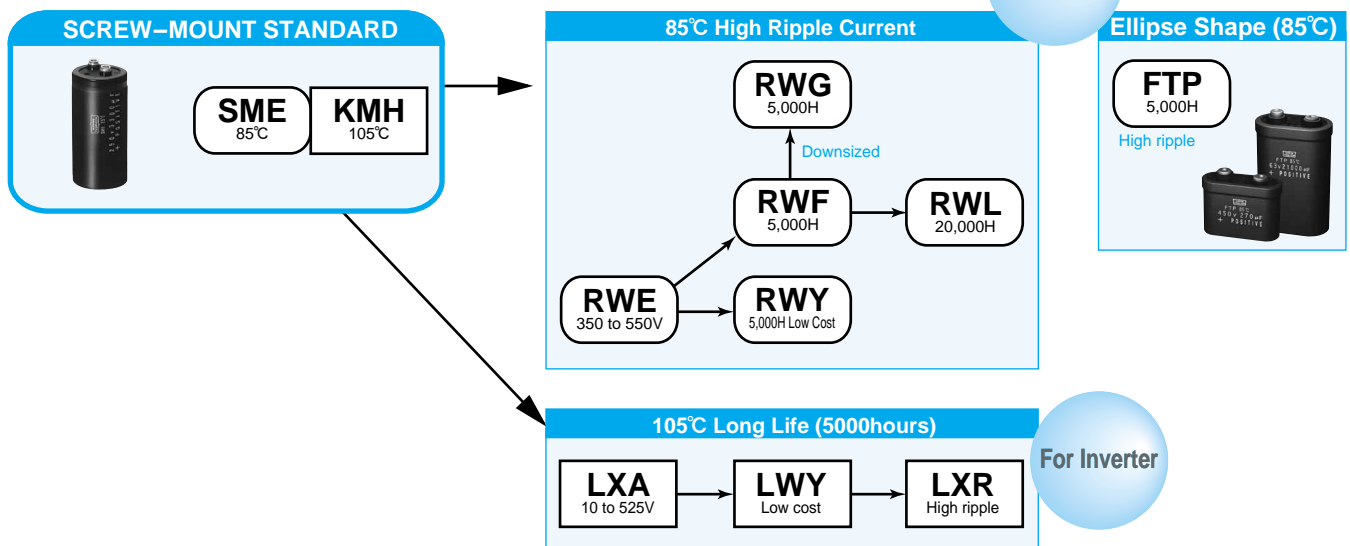



# PRECAUTIONS AND GUIDELINES

For conductive polymer aluminum electrolytic solid capacitors, please refer to PRECAUTIONS AND GUIDELINES (Conductive Polymer)

## Designing Device Circuits

**1** Select the capacitors to suit installation and operating conditions, and use the capacitors to meet the performance limits prescribed in this catalog or the product specifications.

### 2 Polarity

Aluminum Electrolytic Capacitors are polarized. Apply neither reverse voltage nor AC voltage to polarized capacitors. Using reversed polarity causes a short circuit or venting. Before use, refer to the catalog, product specifications or capacitor body to identify the polarity marking. (The shape of rubber seal does not represent the directional rule for polarity.) Use a bi-polar type of non-solid aluminum electrolytic capacitor for a circuit where the polarity is occasionally reversed. However, note that even a bi-polar aluminum electrolytic capacitor must not be used for AC voltage applications.

### 3 Operating voltage

Do not apply a DC voltage which exceeds the full rated voltage. The peak voltage of a superimposed AC voltage (ripple voltage) on the DC voltage must not exceed the full rated voltage. A surge voltage value, which exceeds the full rated voltage, is prescribed in the catalogs, but it is a restricted condition, for especially short periods of time.

### 4 Ripple current

The rated ripple current has been specified at a certain ripple frequency. The rated ripple current at several frequencies must be calculated by multiplying the rated ripple current at the original frequency using the frequency multipliers for each product series. For more details, refer to the paragraph on Aluminum Electrolytic Capacitor Life.

### 5 Category temperature

The use of a capacitor outside the maximum rated category temperature will considerably shorten the life or cause the capacitor to vent.

The relation between the lifetime of aluminum electrolytic capacitors and ambient temperature follows Arrhenius' rule that the lifetime is approximately halved with each 10°C rise in ambient temperature.

### 6 Life expectancy

Select the capacitors to meet the service life of a device.

### 7 Charge and discharge

Do not use capacitors in circuits where heavy charge and discharge cycles are frequently repeated. Frequent and sharp heavy discharging cycles will result in decreasing capacitance and damage to the capacitors due to generated heat. Specified capacitors can be designed to meet the requirements of charging-discharging cycles, frequency, operating temperature, etc.

### 8 Failure mode of capacitors

Non-solid aluminum electrolytic capacitors, in general, have a lifetime which ends in an open circuit, the period is dependent upon temperature. Consequently the lifetime of capacitors can be extended by reducing the ambient temperature and/or ripple current.

### 9 Insulating

a) Electrically isolate the following parts of a capacitor from the negative terminal, the positive terminal and the circuit traces.

- The outer can case of a non-solid aluminum capacitor.
- The dummy terminal of a non-solid aluminum capacitor, which is designed for mounting stability.

b) The outer sleeve of a capacitor is not assured as an insulator (Except for screw type). For applications that require an insulated outer sleeve, a custom-design capacitor is recommended.

### 10 Condition

Do not use/expose capacitors to the following conditions.

- a) Oil, water, salty water storage in damp locations.
- b) Direct sunlight
- c) Toxic gases such as hydrogen sulfide, sulfurous acid, nitrous acid, chlorine or its compounds, and ammonium
- d) Ozone, ultraviolet rays or radiation
- e) Severe vibration or mechanical shock conditions beyond the limits prescribed in the catalogs or the product specification.

### 11 Mounting

a) The paper separators and the electrolytic-conductive electrolytes in a non-solid aluminum electrolytic capacitor are flammable.

Leaking electrolyte on a printed circuit board can gradually erode the copper traces, possibly causing smoke or burning by short-circuiting the copper traces.

Verify the following points when designing a PC board.

- Provide the appropriate hole spacing on the PC board to match the terminal spacing of the capacitor.
- Make the following open space over the vent so that the vent can operate correctly.

Case diameter	Clearance
φ6.3 to φ16mm	2mm minimum
φ18 to φ35mm	3mm minimum
φ40mm and up	5mm minimum

- Do not place any wires or copper traces over the vent of the capacitor.
  - Installing a capacitor with the vent facing the PC board needs an appropriate ventilation hole in PC board.
  - Do not pass any copper traces beneath the seal side of a capacitor. The trace must pass 1 or 2mm to the side of the capacitor.
  - Avoid placing any heat-generating objects adjacent to a capacitor or even on the reverse side of the PC board.
  - Do not pass any via holes underneath a capacitor.
  - In designing double-sided PC boards, do not locate any copper trace under the seal side of a capacitor.
- b) Do not mount the terminal side of a screw mount capacitor downwards. If a screw terminal capacitor is mounted on its side, make sure the positive terminal is higher than the negative terminal.

Do not tighten the screws of the terminals and the mounting clamps over the specified torque prescribed in the catalog or the production specification.

c) For a surface mount capacitor, design the copper pads of the PC board in accordance with the catalog or the product specifications.

### 12 Others

- a) The electrical characteristics of capacitors vary in respect to temperature, frequency and service life. Design the device circuits by taking these changes into account.
- b) Capacitors mounted in parallel need the current to flow equally through the individual capacitors.
- c) Capacitors mounted in series require resistors in parallel with the individual capacitors to balance the voltage.
- d) Using capacitor for applications which always consider safety. Consult with our factory before use in applications which can affect human life.(space equipment, aerial equipment, nuclear equipment, medical equipment, vehicle control equipment, etc) Please note that the product, which is

designed only for specific usage can not be used in other usages.(ex. Photo flash type, etc.)

## Installing Capacitors

### 1 Installing

- a) Used capacitors are not reusable, except in the case that the capacitors are detached from a device for periodic inspection to measure their electrical characteristics.
  - b) If the capacitors have self charged, discharge in the capacitors through a resistor of approximately 1kΩ before use.
  - c) If capacitors are stored at a temperature of 35°C or more and more than 75%RH, the leakage current may increase. In this case, they can be reformed by applying the rated voltage through a resistor of approximately 1kΩ.
  - d) Verify the rated capacitance and voltages of the capacitors when installing.
  - e) Verify the polarity of the capacitors.
  - f) Do not use the capacitors if they have been dropped on the floor.
  - g) Do not deform the cases of capacitors.
  - h) Verify that the lead spacing of the capacitor fits the hole spacing in the PC board before installing the capacitors. Some standard pre-formed leads are available.
  - i) For pin terminals or snap-in terminals, insert the terminals into PC board and press the capacitor downward until the bottom of the capacitor body reaches PC board surface.
  - j) Do not apply any mechanical force in excess of the limits prescribed in the catalogs or the product specifications of the capacitors.
- Also, note the capacitors may be damaged by mechanical shocks caused by the vacuum/insertion head, component checker or centering operation of an automatic mounting or insertion machine.

### 2 Soldering and Solderability

- a) When soldering with a soldering iron
  - Soldering conditions (temperature and time) should be within the limits prescribed in the catalogs or the product specifications.
  - If the terminal spacing of a capacitor does not fit the terminal hole spacing of the PC board, reform the terminals in a manner to minimize a mechanical stress into the body of the capacitor.
  - Remove the capacitors from the PC board, after the solder is completely melted, reworking by using a soldering iron minimizes the mechanical stress to the capacitors.
  - Do not touch the capacitor body with the hot tip of the soldering iron.
- b) Flow soldering
  - Do not dip the body of a capacitor into the solder bath only dip the terminals in. The soldering must be done on the reverse side of PC board.
  - Soldering conditions (preheat, solder temperature and dipping time) should be within the limits prescribed in the catalogs or the product specifications.
  - Do not apply flux to any part of capacitors other than their terminals.
  - Make sure the capacitors do not come into contact with any other components while soldering.
- c) Reflow soldering
  - Soldering conditions (preheat, solder temperature and dipping time) should be within the limits prescribed in the catalogs or the product specifications.
  - When setting the temperature infrared heaters, consider that the infrared absorption causes material to be discolored and change in appearance.
  - Do not solder capacitors more than once using reflow. If you need to twice, be sure to consult with us.

- Make sure capacitors do not come into contact with copper traces.
- d) Do not re-use surface mount capacitors which have already been soldered.  
In addition, when installing a new capacitor onto the assembly board to rework, remove old residual flux from the surface of the PC board, and then use a soldering iron within the prescribed conditions.
- e) Confirm before running into soldering that the capacitors are for reflow soldering.

### 3 Handling after soldering

- Do not apply any mechanical stress to the capacitor after soldering onto the PC board.
- a) Do not lean or twist the body of the capacitor after soldering the capacitors onto the PC board.
  - b) Do not use the capacitors for lifting or carrying the assembly board.
  - c) Do not hit or poke the capacitor after soldering to PC board.  
When stacking the assembly board, be careful that other components do not touch the aluminum electrolytic capacitors.
  - d) Do not drop the assembly board.

### 4 Cleaning PC boards

- a) Do not wash capacitors by using the following cleaning agents.
  - Halogenated solvents; cause capacitors to fail due to corrosion.
  - Alkali system solvents; corrode (dissolve) an aluminum case.
  - Petroleum system solvents; cause the rubber seal material to deteriorate.
  - Xylene; causes the rubber seal material to deteriorate.
  - Acetone; erases the marking.

Solvent resistant capacitors are only suitable for washing using the cleaning conditions prescribed in the catalogs or the product specifications. In particular, ultrasonic cleaning will accelerate damaging capacitors.
- b) Verify the following points when washing capacitors.
  - Monitor conductivity, pH, specific gravity, and the water content of cleaning agents. Contamination adversely affects these characteristics.
  - Be sure not to expose the capacitors under solvent rich conditions or keep capacitors inside a closed container. In addition, please dry the solvent sufficiently on the PC board and the capacitor with an air knife (temperature should be less than the maximum rated category temperature of the capacitor) over 10 minutes.  
Aluminum electrolytic capacitors can be characteristically and catastrophically damaged by halogen ions, particularly by chlorine ions, though the degree of the damage mainly depends upon the characteristics of the electrolyte and rubber seal material. When halogen ions come into contact with the capacitors, the foil corrodes when voltages applied. This corrosion causes ; extremely high leakage current, which causes in line with, venting, and an open circuit.  
Global environmental warnings (Greenhouse effects and other environmental destruction by depletion of the ozone layer), new types of cleaning agents have been developed and commercialized as substitutes for CFC-113,1,1,2-trichloroethylene and 1,1,1-trichloroethylene. The following are recommended as cleaning conditions for some of new cleaning agents.

#### –Higher alcohol system cleaning agents

Recommended cleaning agents:  
 Pine Alpha ST-100S (Arakawa Chemical)  
 Clean Through 750H, 750K, 750L, and 710M (Kao)  
 Technocare FRW-14 through 17 (Toshiba)  
 Cleaning conditions:



## PRECAUTIONS AND GUIDELINES

Using these cleaning agents capacitors are capable of withstanding immersion or ultrasonic cleaning for 10 minutes at a maximum liquid temperature of 60°C. Find optimum condition for washing, rinsing, and drying. Be sure not to rub the marking off the capacitor by contacting any other components or the PC board. Note that shower cleaning adversely affects the markings on the sleeve.

### –Non-Halogenated Solvent Cleaning

AK225AES (Asahi Glass)

Cleaning conditions:

Solvent resistant capacitors are capable of withstanding any one of immersion, ultrasonic or vapor cleaning for 5 minutes; exception is 2 minutes max. for KRE, and KRE-BP series capacitors and 3 minutes for SRM series capacitors. However, from a view of the global environmental problems, these types of solvent will be banned in near future. We would recommend not using them as much as possible.

### Isopropyl alcohol cleaning agents

IPA (Isopropyl Alcohol) is one of the most acceptable cleaning agents; it is necessary to maintain a flux content in the cleaning liquid at a maximum limit of 2 Wt.%.

## 5 Precautions for using adhesives and coating materials

- a) Do not use any adhesive and coating materials containing halogenated solvent.
- b) Verify the following before using adhesive and coating material.
  - Remove flux and dust leftover between the rubber seal and the PC board before applying adhesive or coating materials to the capacitor.
  - Dry and remove any residual cleaning agents before applying adhesive and coating materials to the capacitors. Do not cover over the whole surface of the rubber seal with the adhesive or coating materials.
  - For permissible heat conditions for curing adhesives or coating materials, follow the instructions in the catalogs or the product specifications of the capacitors.
  - Covering over the whole surface of the capacitor rubber seal with resin may result in a hazardous condition because the inside pressure cannot release completely. Also, a large amount of halogen ions in resins will cause the capacitors to fail because the halogen ions penetrate into the rubber seal and the inside of the capacitor.
- c) Some of coating material cannot be cured over the capacitor. Please note that loose luster and whitening on the surface of the outer sleeve might be caused according to the kind of solvents used for mounting adhesives and coating agents.

## 6 Fumigation

In many cases when exporting or importing electronic devices, such as capacitors, wooden packaging is used. In order to control insects, many times, it becomes necessary to fumigate the shipments. Precautions during "Fumigation" using halogenated chemical such as Methyl Bromide must be taken. Halogen gas can penetrate packaging materials used, such as, cardboard boxes and vinyl bags. Penetration of the halogenide gas can cause corrosion of Electrolytic capacitors.

## The Operation of Devices

- a) Do not touch a capacitor directly with bare hands.
- b) Do not short-circuit the terminal of a capacitor by letting it come into contact with any conductive object.

Also, do not spill electric-conductive liquid such as acid or alkaline solution over the capacitor.
- c) Do not use capacitors in circumstance where they would be subject to exposure to the following materials exist or expose.
  - Oil, water, salty water or damp location.
  - Direct sunlight.

- Toxic gases such as hydrogen sulfide, sulfurous acid, nitrous acid, chlorine or its compounds, and ammonium.
- Ozone, ultraviolet rays or radiation.
- Severe vibration or mechanical shock conditions beyond the limits prescribed in the catalogs or product specification.

## Maintenance Inspection

- a) Make periodic inspections of capacitors that have been used in industrial applications. Before inspection, turn off the power supply and carefully discharge the electricity in the capacitors. Verify the polarity when measuring the capacitors with a volt-ohm meter. Also, do not apply any mechanical stress to the terminals of the capacitors.
- b) The following items should be checked during the periodic inspections.
  - Significant damage in appearance : venting and electrolyte leakage.
  - Electrical characteristics: leakage current, capacitance,  $\tan\delta$  and other characteristics prescribed in the catalogs or product specifications.We recommend replacing the capacitors if the parts are out of specification.

## In Case of Venting

- a) If a non-solid aluminum electrolytic capacitor expels gas when venting, it will discharge odors or smoke, or burn in the case of a short-circuit failure. Immediately turn off or unplug the main power supply of the device.
- b) When venting, a non-solid aluminum electrolytic capacitor blows out gas with a temperature of over 100°C. (A solid aluminum electrolytic capacitor discharges decomposition gas or burning gas while the outer resin case is burning.) Never expose the face close to a venting capacitor. If your eyes should inadvertently become exposed to the spouting gas or you inhale it, immediately flush the open eyes with large amounts of water and gargle with water respectively. If electrolyte is on the skin, wash the electrolyte away from the skin with soap and plenty of water. Do not lick the electrolyte of non-solid aluminum electrolytic capacitors.

## Storage

We recommend the following conditions for storage.

- a) Do not store capacitors at a high temperature or in high humidity. Store the capacitors indoors at a temperature of 5 to 35°C and a humidity of less than 75%RH.
- b) Store the capacitors in places free from water, oil or salt water.
- c) Store the capacitors in places free from toxic gasses (hydrogen sulfide, sulfurous acid, chlorine, ammonium, etc.)
- d) Store the capacitors in places free from ozone, ultraviolet rays or radiation.
- e) Keep capacitors in the original package.
- f) It is not applied to a regulation of JEDEC J-STD-020(Rev.C). But MSL (Moisture Sensitivity Level) is suitable for Level 1. A time limit for keeping goods under packed situation is within 3 years after manufacturing.

## Disposal

Please consult with a local industrial waste disposal specialist when disposing of aluminum electrolytic capacitors.

## Catalogs

Specifications in catalogs may be subject to change without notice. For more details of precautions and guidelines for aluminum electrolytic capacitors, please refer to Engineering Bulletin No. 634A.



## Structure of Aluminum Electrolytic Capacitors

The aluminum electrolytic capacitor contains an internal element of an anode foil, a cathode foil and paper separator rolled together, impregnated with an electrolyte, then attached to external terminals connecting the tabs with the anode or the cathode foils, and sealed in a can case.

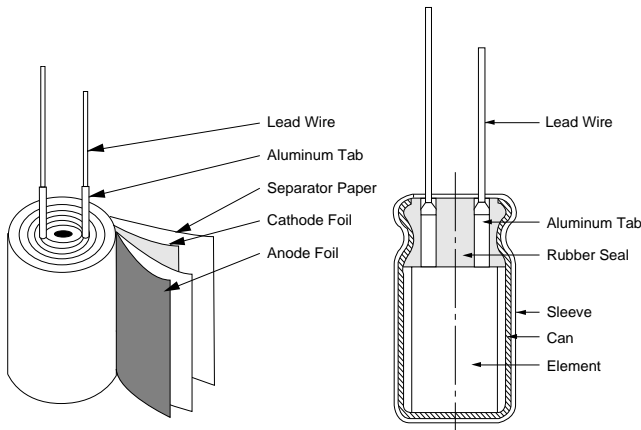

Among various types of capacitors, an aluminum electrolytic capacitor offers large CV to volume and features low cost. The capacitance (C) of aluminum electrolytic capacitors, as well as other capacitors, is expressed by the following equation:

$$C = 8.854 \times 10^{-12} \times \frac{\epsilon S}{d} \text{ (F)}$$

Where :  $\epsilon$ =Dielectric constant  
S=Surface area of dielectric (m<sup>2</sup>)  
d=Thickness of dielectric (m)

This equation shows that the capacitance increases in proportion as the dielectric constant becomes high, its surface area becomes large and the thickness of dielectric becomes thin. In aluminum electrolytic capacitors the dielectric constant of an aluminum oxide (Al<sub>2</sub>O<sub>3</sub>) layer is 8 to 10, which is not as high as compared with the other types of capacitors. However, the dielectric layer of the aluminum oxide is extremely thin (about 15Å per volt) and the surface area is very large. An electrochemical formed electrode foil makes the dielectric on the etched surface of aluminum electrode foil. Electrochemical etching creates 20 to 100 times more surface area as plain foil. Therefore, an aluminum electrolytic capacitor can offer a large capacitance compared with other types.

## Primary of Composition Material

### Anode aluminum foil:

First, the etching process is carried out electromechanically with a chloride solution which dissolves metal and increases the surface area of the foil; forming a dense network like innumerable microscopic channels. Secondly, the formation process is carried out with a solution such as ammonium borate which forms the aluminum oxide layer (Al<sub>2</sub>O<sub>3</sub>) as a dielectric at a thickness of about 1.1 to 1.5nm / volt. The process needs to charge more the rated voltage into the foil.

### Cathode aluminum foil:

As in the first manufacturing process of the positive foil, the cathode foil requires etching process. Generally, it does not require the formation process; therefore, the natural oxide layer of Al<sub>2</sub>O<sub>3</sub>, which gives a characteristic dielectric voltage of 1.0 volts, is formed.

### Electrolyte and separator:

In a non-solid aluminum electrolytic capacitor, the electrolyte, an electrically conductive liquid, functions as a true cathode by contacting the dielectric oxide layer. Accordingly, the "cathode foil" serves as an electrical connection between the electrolyte and terminal.

The separator functions to retain the electrolyte and prevent the anode and cathode foils from short-circuiting.

### Can case and sealing materials:

The foils and separator are wound into a cylinder to make an internal element, which is impregnated with the electrolyte, inserted into an aluminum can case and sealed. During the service life of a capacitor, electrolyte slowly and naturally vaporizes by electrochemical reaction on the boundary of the aluminum foils. The gas will increase the pressure inside the case and finally cause the pressure relief vent to open or the sealing materials to bulge. The sealing material functions not only to prevent electrolyte from drying out but also to allow the gas to escape out of the can case in a controlled manner.

## The Equivalent Circuit

As the equivalent circuit of an aluminum electrolytic capacitor is shown below, it forms a capacitance, a series resistance, an inductance, and a parallel resistance.

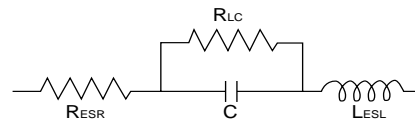

RESR=Equivalent series resistance (ESR)  
RLC =Resistance due to leakage current  
C =Capacitance  
LESL =Equivalent series inductance

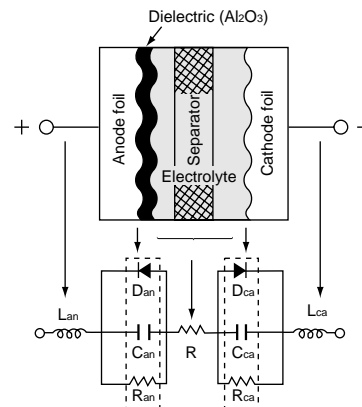

From a composition material point wise, the equivalent circuit is subdivided as follows.

C<sub>an</sub>, C<sub>ca</sub>=Capacitance due to anode and cathodes foils  
R =Resistance of electrolyte and separator  
R<sub>an</sub>, R<sub>ca</sub>=Internal resistance of oxide layer on anode and cathode foils  
D<sub>an</sub>, D<sub>ca</sub>=Diode effects due to oxide layer on anode and cathode foils  
L<sub>an</sub>, L<sub>ca</sub> =Inductance due to anode and cathode terminals

## Basic Electrical Characteristics

### Capacitance:

The capacitance of capacitor is expressed as AC capacitance

by measuring impedance and separating factors. Also, the AC capacitance depends upon frequency, voltage and other measuring methods. In fact, JIS C 5101 prescribes that the series capacitive factor of an equivalent series circuit shall be the capacitance measured at a frequency of 120Hz and applying a maximum AC voltage of 0.5V rms with a DC bias voltage of 1.5 or 2.0V to aluminum electrolytic capacitors. The capacitance of an aluminum electrolytic capacitor becomes smaller with increasing frequency. See the typical behavior shown below.

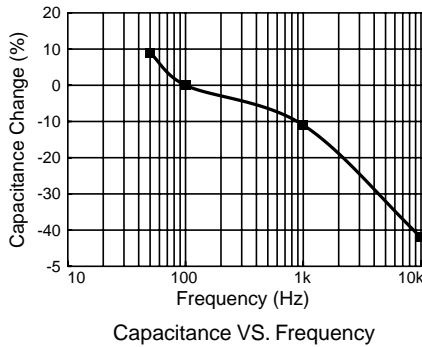

The capacitance value is highly dependent upon temperature and frequency. As the temperature decreases, the capacitance becomes smaller. See the typical behavior shown below.

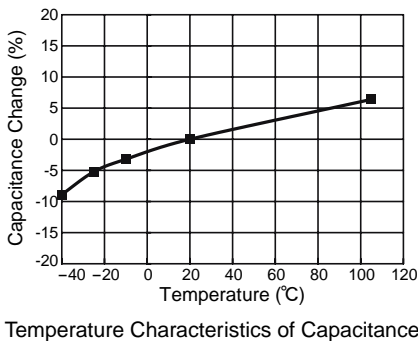

On the other hand, DC capacitance, which can be measured by applying a DC voltage, shows a slightly larger value than the AC capacitance at a normal temperature and has the flatter characteristic over the temperature range.

### tanδ (tangent of loss angle or dissipation factor):

The tanδ is expressed as the ratio of the resistive component (RESR) to the capacitive reactance (1/ωC) in the equivalent series circuit. Its measuring conditions are the same as the capacitance.

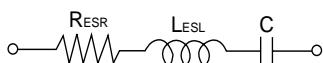

$$\tan\delta = \text{RESR} / (1/\omega C) = \omega C \text{ RESR}$$

Where : RESR=ESR at 120Hz  
 $\omega = 2\pi f$   
 $f = 120\text{Hz}$

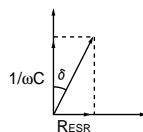

The tanδ shows higher values as the measured frequency increases and the measured temperature decreases.

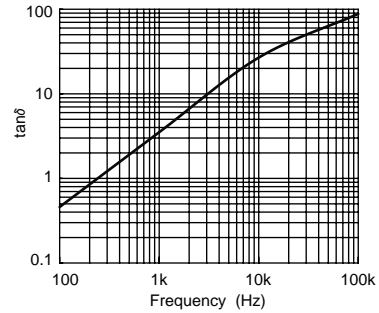

tanδ VS. Frequency

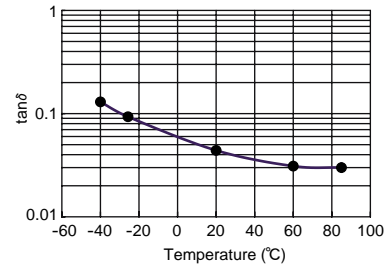

Temperature Characteristics of tanδ

### Equivalent series resistance (ESR):

The ESR is the series resistance consisting of the aluminum oxide layer, electrolyte/separator combination, and other resistance related factors, foil length, foil surface area and others.

The ESR value depends upon the temperature. Decreasing the temperature makes the resistivity of the electrolyte increase and leads to increasing ESR.

As the measuring frequency increases, the ESR decreases and reaches an almost constant value that mainly dominates the frequency-independent resistance relating electrolyte/separator combination.

### Impedance (Z):

The impedance is the resistance of the alternating current at a specific frequency. It is related to capacitance (C) and inductance (L) in terms of capacitive and inductive reactance, and also related to the ESR. It is expressed as follows:

$$Z = \sqrt{\text{ESR}^2 + (X_L - X_C)^2}$$

Where :  $X_C = 1/\omega C = 1/2\pi f C$   
 $X_L = \omega L = 2\pi f L$

As shown below, the capacitive reactance (Xc) dominates at the range of low frequencies, and the impedance decreases with increasing frequency until it reaches the ESR in the middle frequency range. At the range of the higher frequencies the inductive reactance (XL) comes to dominate, so that the impedance increases when increasing the measuring frequency.

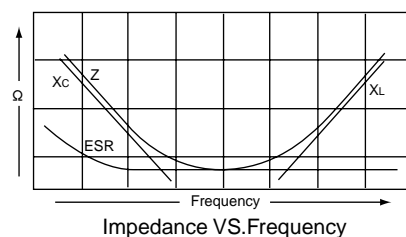

As shown at the next page, the impedance value varies with temperature because the resistance of the electrolyte is strongly affected by temperature.

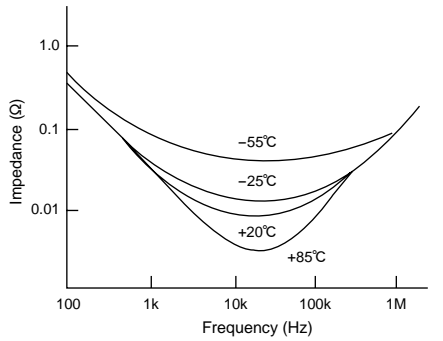

Temperature Characteristics of Impedance

**Leakage current:**

The dielectric of a capacitor has a very high resistance that does not allow DC current to flow. However, due to the characteristics of the aluminum oxide layer that functions as a dielectric in contact with electrolyte, a small amount of current, called leakage current, will flow to reform and repair the oxide layer when a voltage is being applied. As shown below, a high leakage current flows to charge voltage to the capacitor for the first seconds, and then the leakage current will decrease and reach an almost steady-state value with time.

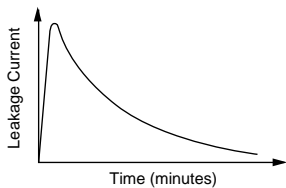

Leakage Current VS. Time

Measuring temperature and voltage influences the leakage current. The leakage current shows higher values as the temperature and voltage increase.

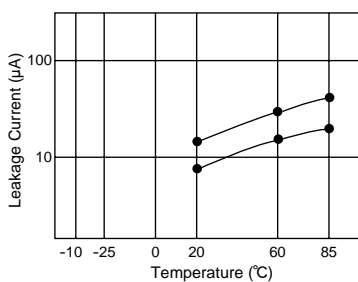

Typical Temperature Characteristics

In general, the leakage current is measured at 20°C by applying the rated voltage to capacitor through a resistor of 1000Ω in series. The leakage current is the value several minutes later after the capacitor has reached the rated voltage. The catalog prescribes the measuring temperature and time.

**Reliability**

**The bathtub curve:**

Aluminum electrolytic capacitors feature failure rates shown by the following bathtub curve.

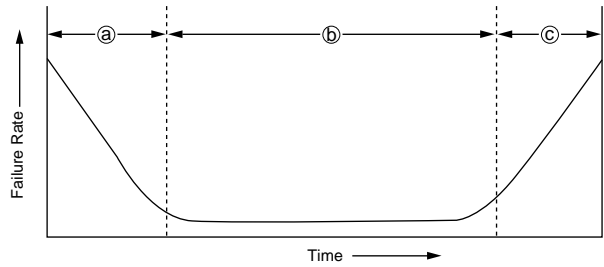

a) Infant failure period

This initial period accounts for the failures caused by deficiencies in design, structure, the manufacturing process or severe misapplications. In other words the initial failures occur as soon as the components are installed in a circuit. In the case of aluminum electrolytic capacitors, these failures do not occur at customers' field because aging process reforms an incomplete oxide layer, or eliminate the defective parts at the aging process and the sorting process. Misapplication of the capacitor such as inappropriate ambient conditions, over-voltage, reverse voltage, or excessive ripple current should be avoided for proper use of the capacitor in a circuit.

b) Useful life period

This random failure period exhibits an extremely low failure rate. These failures are not related to operating time but to application conditions. During this period, non-solid aluminum electrolytic capacitors lose a small amount of electrolyte. The electrolyte loss shows as a slow decrease in capacitance and a slow increase in tanδ and ESR. Non-solid aluminum electrolytic capacitors still exhibit lower catastrophic failures than semiconductors and solid tantalum capacitors.

c) Wear-out failure period

This period reflects a deterioration in the component properties of the capacitor ; the failure rate increases with time. Non-solid aluminum electrolytic capacitors end their useful life during this period.

**Failure types:**

The two types of failures are classified as catastrophic failures and wear-out failures as follows.

1) Catastrophic failures

This is a failure mode that destroys the function of the capacitor like a short circuit or open circuit failure.

2) Wear-out failures

This is a failure mode where gradually deteriorates; the electrical parameters of the capacitor. The criteria of judging the failures, vary with application and design factors. Capacitance decreases and tanδ increases are caused by the loss of electrolyte in the wear-out failure period. This is primary due to loss of electrolyte by diffusion (as vapor) through the sealing material. Gas molecules can diffuse out through the material of the end seal. High temperature increase the electrolyte vapor pressure within the capacitor and the diffusion rate is therefore increased. This increases internal pressure may cause the seal to bulge caused by elevated temperatures. This bulging may accelerate diffusion and mechanically degrade the seal. Factors that can increase the capacitor temperature, such as ambient temperature and ripple current, can accelerate the wear-out phase of a capacitor.

**Failure modes:**

Aluminum electrolytic capacitors show various failure modes in different applications. (See Table 1.)

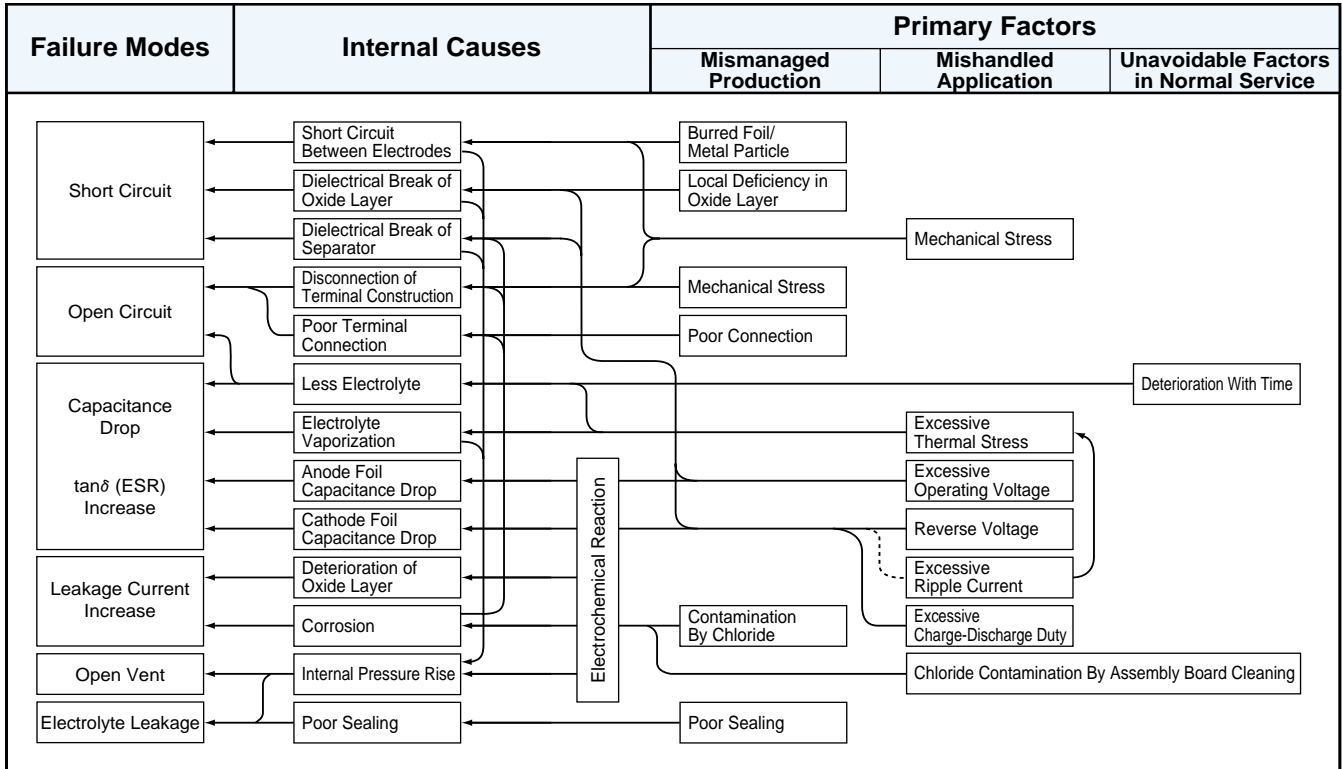

Table 1

## Life of Aluminum Electrolytic Capacitors

The life of aluminum electrolytic capacitors is largely dependent on environmental and electrical factors. Environmental factors include temperature, humidity, atmospheric pressure and vibration. Electrical factors include operating voltage, ripple current and charge-discharge duty cycles. The factor of temperature (ambient temperature and internal heating due to ripple current) is the most critical to the life of aluminum electrolytic capacitors.

### General formula to estimate lifetime:

The lifetime of non-solid aluminum electrolytic capacitors is generally expressed by using three elements representing the effects of ambient temperature, applying voltage and ripple current, which is shown by the following equation:

$$L_x = L_0 \cdot K_{Temp} \cdot K_{Voltage} \cdot K_{Ripple}$$

- Where :  $L_x$  =Lifetime of capacitor to be estimated  
 $L_0$  =Base lifetime of capacitor  
 $K_{Temp}$  =Ambient temperature acelation term  
 $K_{Voltage}$  =Voltage acelation term  
 $K_{Ripple}$  =Ripple current acelation term

### $K_{Temp}$ (Effects of ambient temperature on life):

Because an aluminum electrolytic capacitor is essentially an electrochemical component, increased temperatures accelerate the chemical reaction producing gas within the capacitor which is diffused through the end seal, and consequently accelerates a gradual decrease in capacitance and a gradual increase in  $\tan\delta$  and ESR. The following equation has been experimentally found to express the relationship between the temperature acceleration factor and the deterioration of the capacitor.

$$L_x = L_0 \cdot K_{Temp} = L_0 \cdot B^{(T_0 - T_x) / 10}$$

$$K_{Temp} = B^{(T_0 - T_x) / 10}$$

- Where :  $L_x$  =Lifetime (hour) of capacitor to be estimated  
 $L_0$  =Base lifetime (hour) of capacitor  
 $T_0$  =Maximum rated category temperature (°C) of capacitor shown in catalog  
 $T_x$  =Actual ambient temperature (°C) of capacitor  
 $B$  =Temperature acceleration factor ( $\approx 2$ )

This equation is similar to Arrhenius' equation that expresses a relationship between chemical reaction rates and temperature, and called Arrhenius' rule of aluminum electrolytic capacitors. The temperature acceleration factor (B) is approximately 2 over an ambient temperature range ( $T_x$ ) from 40°C to the maximum rated category temperature of each capacitor. It means that the lifetime is approximately halved with every 10°C rise in ambient temperature and can be extended by using the capacitors at low temperatures. For an ambient temperature range ( $T_x$ ) of 20°C to 40°C, the factor B will be close to 2, and the lifetime will actually be extended. However, operating and surrounding conditions, especially the operating conditions influence ambient temperatures mutually. The ambient temperature in this range will be very changeable; therefore, lifetime estimation under 40°C should use 40 as  $T_x$ .

### $K_{Voltage}$ (Effects of applying voltage to life):

Miniature and large sized aluminum electrolytic capacitors for popular applications, such as surface mount types, radial lead types, snap-in types and block types, have little voltage effect on their life. Other factors like temperature and ripple current determine the life in comparison with voltage, as long as the capacitors are used at voltages and temperatures within the specifications prescribed in the catalog. Consequently,  $K_{Voltage}=1$  is used for these capacitors. 350V and higher screw-mount terminal types of capacitors for customer-use power electronics applications allow the life time to extend by applying low voltage, relating to the characteristics of their aluminum oxide layer. RWE, RWY, RWL, RWF, LX(Screw-mount), LXA(Screw-mount) and LXR series are applicable to the method. For  $K_{Voltage}$  values of these products, please contact a representative of Nippon Chemi-Con.

### $K_{Ripple}$ (Effects of ripple current to life):

Aluminum electrolytic capacitors have higher  $\tan\delta$  than any other types of capacitors; therefore, the ripple current gives aluminum electrolytic capacitors higher internal heat. Be sure to check the rated ripple current which is specified in the catalog for assuring the life.



# PRECAUTIONS AND GUIDELINES

The ripple current through the capacitor produces heat by dissipating power from the capacitor. This leads to temperature increase. Internal heating produced by ripple currents can be expressed by:

$$W=(I_{\text{Ripple}})^2 \cdot R_{\text{ESR}} + V \cdot I_{\text{Leakage}}$$

Where :  $W$  =Internal power loss  
 $I_{\text{Ripple}}$  =R.M.S. ripple current  
 $R_{\text{ESR}}$  =Internal resistance (ESR) at ripple frequency  
 $V$  =Applied voltage  
 $I_{\text{Leakage}}$ =Leakage current

Leakage current may be 5 to 10 times higher than the values measured at 20°C, but compared with Iripple, the leakage current value is very small and negligible. Thus, the above equation can be simplified:

$$W=(I_{\text{Ripple}})^2 \cdot R_{\text{ESR}}$$

The following equation gives the internal heat rise; it is heat rise to stable condition. ( It is necessary to input several factors.):

$$(I_{\text{Ripple}})^2 \cdot R_{\text{ESR}} = \beta \cdot A \cdot \Delta T$$

Where :  $\beta$  =Heat transfer constant  
 $A$  =Surface area of can case  
 $A=(\pi/4) \cdot D \cdot (D+4L)$   
 Where :  $D$ =Can diameter  
 $L$ =Can length  
 $\Delta T$ =An increase in core temperature by internal heating due to ripple current  
 $(\Delta T=\text{Core temperature}-\text{Ambient temperature})$

From the above equation, internal temperature rise ( $\Delta T$ ) produced by ripple current is given by:

$$\Delta T=(I_{\text{Ripple}})^2 \cdot R_{\text{ESR}} / (\beta \cdot A)$$

When the ripple frequency is 120Hz,  $R_{\text{ESR}}$  at 120Hz is expressed by

$$R_{\text{ESR}} = \tan \delta / (\omega \cdot C)$$

$$\Delta T = (I_{\text{Ripple}})^2 \cdot \tan \delta / (\beta \cdot A \cdot \omega \cdot C)$$

Where :  $\tan \delta$ =120Hz value  
 $\omega = 2\pi \cdot f = 2\pi \cdot 120\text{Hz}$   
 $C$  =120Hz capacitance value

As above equation,  $\Delta T$  varies with frequency of ripple, frequency and temperature dependent ESR, and application dependent  $\beta$  (even ripple current is constant). We really recommend that customers measure  $\Delta T$  with a thermocouple at the actual operating conditions of the application in lieu of using the above equation. (Another approximation of  $\Delta T$  will be stated later.)

As mentioned in the paragraph of  $K_{\text{Temp}}$ , aluminum electrolytic capacitors will slowly increase in  $\tan \delta$  and ESR during their service life. The application without ripple current has no influence on the life of the capacitor even though the ESR will increase during life. In other words, the application with ripple current makes  $\Delta T$  increase; furthermore, a  $\Delta T$  increase results in ESR increase. The ESR increase then makes  $\Delta T$  increase. It is a chain reaction. Theoretically, the ripple current acceleration term ( $K_{\text{Ripple}}$ ) cannot be simply expressed like the ambient temperature acceleration term ( $K_{\text{Temp}}$ ). Practically, the ripple current acceleration term ( $K_{\text{Ripple}}$ ) can be approximately expressed by an equation using a  $\Delta T$  initially measured. The following table shows the ripple current acceleration term ( $K_{\text{Ripple}}$ ) for each capacitor design group.

$K_{\text{Ripple}}$	Products		
	Type	Series	
$2^{(-\Delta T / 5)}$	Surface mount	MVS, MVA, MV, MVE, MVK, MKA, MZA, MVY, MLA MVJ, MVL, MVH, MV-BP, MVK-BP	
	Radial lead	KMA, KME-BP, KRE, KRG, LLA, SME, SMQ, SME-BP, SMG, SRA, SRE, SRG, SRM	
	Screw-mount terminal	KW	
$2^{(\Delta T_0 - \Delta T) / 5}$	$\Delta T_0 = 5 \text{ deg}$	Radial lead	FL, GXE( $T_0 \leq 105^\circ\text{C}$ ), KLG, KME, KMQ, KMF, KMG, KMH, KMX, KXG, PAG, LBG, LXV, LXZ, KZM, KZH, KZE, KY, KXJ, GPA, KLJ, KMR
		Pin terminal	KMH, KMM, KMQ, LXG, LXM, LXH, LXQ, CHA
		Screw-mount terminal	LXA (10 to 250V <sub>dc</sub> ), KMH
	$\Delta T_0 = 5 \text{ to } 10 \text{ deg}$ Contact us for details	Radial lead	SMH
		Pin terminal	SMH, SMM, SMQ, SLM, RWE-LR
		Screw-mount terminal	SME
$2^{[-2+(25-\Delta T) / b]}$	Screw-insert terminal	LXA (350 to 525V <sub>dc</sub> ), RWE, RWF, RWL, LXR, RWY, RWG	
Note : $\Delta T$ = An increase (deg) in core temperature produced by internal heating due to actual operating ripple current. The $\Delta T$ is the difference between the core temperature and ambient temperature measured at the actual operating conditions. $\Delta T_0$ = An increase (deg) in core temperature by internal heating due to rated ripple current. $b$ = Factor $b$ varies from 5 to 10 by the conditions of ripple frequency and $\Delta T$ . Please contact a representative of Nippon Chemi-Con for the details			

Note that a  $\Delta T$  over a certain maximum limit may over-heat the capacitors, though the lifetime estimation will not give you practical lifetime. For instance, the following shows a guide limit of  $\Delta T$  at each ambient temperature for 105°C maximum rated products.

Ambient temperature $T_x$ (°C)	85	105
Guide limit of $\Delta T$ (deg)	15	5
Core temperature (= $T_x + \Delta T$ )	100	110

## Approximation of $\Delta T$

Estimation of the lifetime requires two temperature measurements; first obtain  $\Delta T$  by actually measuring the core temperature, inserting the thermocouple inside the operating capacitor and secondary, the ambient temperature. A more convenient way to get the  $\Delta T$  is to convert the surface temperature of the capacitor case and the ambient temperature by using a coefficient specified for each case diameter as follows:

$$\Delta T = K_c \cdot (T_s - T_x)$$

Where :  $K_c$ =Coefficient from table below  
 $T_s$ =Surface temperature (deg) of capacitor can case  
 $T_x$ =Ambient temperature (deg)

No air flow conditions.

Diameter (mm)	$\phi 5$ to $\phi 8$	$\phi 10$	$\phi 12.5$	$\phi 16$	$\phi 18$	$\phi 22$	$\phi 25$	
$K_c$	1.10	1.15	1.20	1.25	1.30	1.35	1.40	
Diameter (mm)	$\phi 30$	$\phi 35$	$\phi 40$	$\phi 50$	$\phi 63.5$	$\phi 76$	$\phi 89$	$\phi 100$
$K_c$	1.50	1.65	1.75	1.90	2.20	2.50	2.80	3.10

Also, you can roughly estimate a  $\Delta T$  by using the following equation without need to measure.

$$\Delta T = \Delta T_0 \cdot (I_x / I_0)^2$$

Where :  $\Delta T_0 = 5$  deg for 105°C maximum rated capacitors.  
 $I_0$  = Rated ripple current (ARMS) : if its frequency is different from operating ripple current  $I_x$ , it needs converting by using a frequency multiplier prescribed in the catalog.  
 $I_x$  = Operating ripple current (ARMS) actually flowing into a capacitor

Like switching power supplies, if the operating ripple current consists of commercial frequency element and switching frequency element(s), an internal power loss is expressed by the following equation.

$$W = (I_{f1})^2 \cdot ESR_{f1} + (I_{f2})^2 \cdot ESR_{f2} + \dots + (I_{fn})^2 \cdot ESR_{fn}$$

Where :  $W$  = Internal power loss  
 $I_{f1} \dots I_{fn}$  = Ripple currents at every frequencies  $f_1 \dots f_n$   
 $ESR_{f1} \dots ESR_{fn} = ESR$ 's at every frequencies  $f_1 \dots f_n$

The above equation can be transformed into another equation to get a ripple current value in accordance with the frequency of the rated ripple current, each of  $ESR_{f1} \dots ESR_{fn}$  is approximately equal to  $ESR_{f0}$  divided by square value of the frequency multiplier ( $F_{f1} \dots F_{fn}$ ). Here  $ESR_{f0}$  is the value at the frequency of the rated ripple current and  $F_{f1} \dots F_{fn}$  is a conversion coefficient from one frequency to another in accordance with the frequency  $f_1 \dots f_n$ .

$$\begin{aligned} ESR_{f1} &= ESR_{f0} / (F_{f1})^2 \\ &\vdots \\ ESR_{fn} &= ESR_{f0} / (F_{fn})^2 \end{aligned}$$

Relationship of  $w = (L_{Ripple})^2 \cdot RESR$  leads  $I_x$  as follows:

$$I_x = \sqrt{W / ESR_{f0}}$$

The above is rewritten in the following equation:

$$I_x = \sqrt{(I_{f1}/F_{f1})^2 + (I_{f2}/F_{f2})^2 + \dots + (I_{fn}/F_{fn})^2}$$

Where :  $I_x$  = Ripple current in accordance with the frequency of the rated ripple current  
 $I_{f1} \dots I_{fn}$  = Operating ripple currents at every frequency  $f_1 \dots f_n$   
 $F_{f1} \dots F_{fn}$  = Frequency multipliers for every frequency  $f_1 \dots f_n$  prescribed in the catalog, based on the fact that the internal resistance of a capacitor varies with frequency.

## Cleaning Agents

- Cleaning agents penetrate into a capacitor.  
Solvent contacts the rubber seal of a capacitor. Some percentage of solvent does not penetrate but a percentage succeeds in entering and defusing inside the capacitor.
- Cleaning agents decompose and release halogen ions.  
In the electrolyte of the inside element, the halides in the cleaning agents become hydrolyzed and release halogen ions as follows,

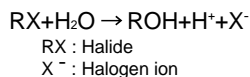

### c. Corrosion

The halogen ions attack the aluminum foil by the following anodic half-cell reaction:

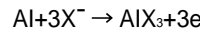

The  $AlX_3$  further becomes hydrolyzed and release the halogen ion again:



The halogen ions release by this hydrolysis reaction further attacks the aluminum according to the previous reaction formula, and these reactions are repeated and accelerated when voltage and temperature is applied. Also, the hydrogen ions increase the local acidity which causes the oxide dielectric to dissolve. Thus, localized corrosion accelerates to corrode both the aluminum metal and the dielectric. In addition, a terpene or petroleum system cleaning solvent will be absorbed into the rubber seal of the capacitor. The rubber seal finally weakens. An alkaline saponification detergent will damage the aluminum metal and marking. In summary, recommended cleaning agents are halogen free. Terpene, petroleum, alkali detergent and any solvent making the rubber seal material deteriorate are not recommended.

### Compatible cleaning agents:

In line with recent global environmental warnings (Greenhouse effect and other environmental destruction by depletion of the ozone layer), new types of cleaning agents have been commercialized and substituted as CFC-113, 1,1,2-trichloroethylene and 1,1,1-trichloroethylene. The following are recommended cleaning conditions for some of new cleaning agents.

#### Higher alcohol system cleaning agents

Recommended cleaning agents:

Pine Alpha ST-100S (Arakawa Chemical)  
 Clean Through 750H, 750K, 750L, and 710M (Kao)  
 Technocare FRW-14 through 17 (GE Toshiba Silicones)

Cleaning conditions:

- Capacitors are capable of withstanding immersion or ultrasonic cleaning for 10 minutes at a maximum liquid temperature of 60°C using the above cleaning agents. Find the optimum conditions for washing, rinsing, and drying. Be sure not to rub the marking off the capacitor by contact with any other components on the PC board. Note that shower cleaning adversely affects the marking.
- To rinse by water, control the conditions such as temperature and water pressure to avoid sleeve shrinkage.
- Clean Through 750H and similar are weak-alkaline solvents. Do not leave the alkaline on the capacitor after cleaning process.

#### CFCs substitute solvents (HCFC system)

Asahi Glass AK225AES solvent is usable only with solvent resistant type capacitors, which are designed with reinforced seal constructions and modified electrolyte. This product does not penetrate the capacitor and deactivate halogen ions. However, AK225AES is one of the solvents which will have a restricted usage in future from the environmental point of view.



## PRECAUTIONS AND GUIDELINES

### Non-Halogenated Solvent Cleaning

#### **HCFC solvents: AK225AES (Asahi Glass)**

##### Cleaning conditions:

Solvent resistant type capacitors are capable of withstanding immersion, ultrasonic or vapor cleaning for 5 minutes; exception is 2 minutes max. for KRE and KRE-BP series capacitors for 3 minutes and SRM series capacitors.

##### Applicable series (only for solvent resistant products):

Surface mount : MVS, MVA(4 to 63V<sub>dc</sub>), MV, MVE(6.3 to 63V<sub>dc</sub>), MVK, MKA, MZA, MLA, MVY(6.3 to 63V<sub>dc</sub>), MVJ, MVL, MVH(10 to 50V<sub>dc</sub>), MV-BP, MVK-BP, PXF, PXE, PXA, PXH, MZD, MLD

Radial lead : SRM, KRE, KMA, SRG, KRG, SMG(6.3 to 250V<sub>dc</sub>), SME-BP, KMQ(6.3 to 100V<sub>dc</sub>), KMG(6.3 to 250V<sub>dc</sub>), KME-BP, LXZ, LXY, LXV, FL, GXE(10 to 50V<sub>dc</sub>), GXL, LBG, LLA, PS, PSC, PSA, GPA

#### **Isopropyl alcohol cleaning agents**

IPA (Isopropyl Alcohol) is one of the most acceptable cleaning agents; it is necessary to maintain a flux content in the cleaning liquid at a maximum limit of 2 Wt. %, because chlorides in flux dissolves in the cleaning liquid during the cleaning process.

Xylene -additive IPA may make the rubber seal deteriorate.

#### **Non-clean flux**

Both ionic halogen and non-ionic halogens damage the capacitor when they penetrate in through the rubber seal. Note that some of the fluxes called non-halogenated flux contains less ionic halogen activator but actually a large amount of non-ionic halogen.

Per our analysis, AHQ3100K(Asahi) and POZ6(Senjyu) minimize ionic and non-ionic halogens.

#### **Other Precautions to wash capacitors**

- a) Monitor conductivity, pH, specific gravity and water content of cleaning agents. Contamination adversely affects the characteristics.
- b) The solvent may stay between the end seal and the PC board if the capacitor is mounted directly onto the PCB without a small gap. The residual solvent can cause defects. Also, washing for more than the specified time causes solvent residual. Therefore, wash the assembly board for at least 10 minutes at the recommended temperature. Be sure not to expose the capacitors under solvent rich conditions or keep capacitors inside a closed container.
- c) Reforming the leads of the capacitor to fit lead spacing on the PC board causes cleaning agents to get into the inside capacitor. This may result in corrosion to the foil. Therefore, use the capacitors, which fit the hole spacing on the PC board or reform the lead wires in a manner which will not cause mechanical stress to the capacitor body.



# PART NUMBERING SYSTEM

## Product code guide (Snap-in type)

(Example : KMM series, 400V-220 $\mu$ F,  $\phi$ 30 $\times$ 30L)

Please refer to the following table

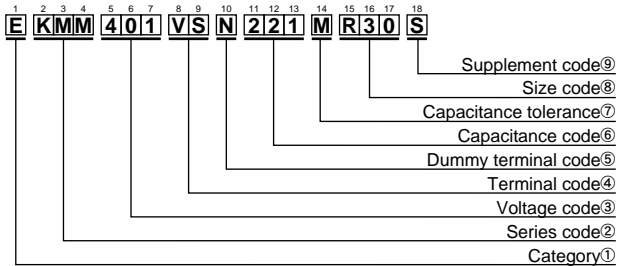

### ①Category

Type	Code 1st
Polar	E

### ②Series code

Series name	Code		
	2nd	3rd	4th
KMM	K	M	M
No series name	C	S	T

### ③Voltage code

Voltage (V)	Code		
	5th	6th	7th
6.3	6	R	3
10	1	0	0
16	1	6	0
25	2	5	0
35	3	5	0
50	5	0	0
63	6	3	0
80	8	0	0
100	1	0	1
160	1	6	1
180	1	8	1
200	2	0	1
220	2	2	1
250	2	5	1
315	3	B	1
350	3	5	1
400	4	0	1
420	4	2	1
450	4	5	1
500	5	0	1

### ④Terminal code

Type	Code	
	8th	9th
VS	V	S
LI	L	I
LR	L	R
LC	L	C
VR	V	R

### ⑤Dummy terminal code

Terminal #	Code 10th
	0
1	S
2	D
3	T

### ⑥Capacitance code

Cap. ( $\mu$ F)	Code		
	11th	12th	13th
10	1	0	0
22	2	2	0
33	3	3	0
47	4	7	0
68	6	8	0
100	1	0	1
220	2	2	1
330	3	3	1
470	4	7	1
680	6	8	1
1,000	1	0	2
2,200	2	2	2
3,300	3	3	2
4,700	4	7	2
6,800	6	8	2
10,000	1	0	3
22,000	2	2	3
33,000	3	3	3
47,000	4	7	3
68,000	6	8	3
100,000	1	0	4
220,000	2	2	4
330,000	3	3	4
470,000	4	7	4
680,000	6	8	4

### ⑦Capacitance tolerance

Tol. (%)	Code 14th
$\pm$ 20	M

### ⑧Size code

$\phi$ D	Code 15th
	20
22	P
25.4	Q
30	R
35	A
Others	S

L	Code	
	16th	17th
15	1	5
20	2	0
25	2	5
30	3	0
35	3	5
40	4	0
45	4	5
50	5	0
55	5	5
60	6	0

### ⑨Supplement code

Sleeve material	Terminal plating material	Code 18th
		PET
PVC	Sn-Pb	C
	Sn100%	B
	Sn-Pb	N

\* Refer to the appendix (Global code) for codes not listed here.



# KMR Series

- Downsized 5mm in height from current snap-ins KMQ series
- Max. 50% up ripple current than same case size of KMQ series
- Endurance with ripple current : 2,000 hours at 105°C
- Rated voltage range : 160 to 450V<sub>dc</sub>, Capacitance range : 100 to 3,900μF
- For inverter control, switching power supplies
- Non solvent resistant type
- RoHS Compliant

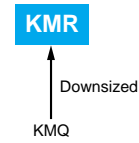

## ◆ SPECIFICATIONS

Items	Characteristics			
Category	-25 to +105°C			
Temperature Range				
Rated Voltage Range	160 to 450V <sub>dc</sub>			
Capacitance Tolerance	±20% (M) (at 20°C, 120Hz)			
Leakage Current	I ≤ 3√CV Where, I : Max. leakage current (μA), C : Nominal capacitance (μF), V : Rated voltage (V) (at 20°C after 5 minutes)			
Dissipation Factor (tanδ)	Rated voltage (V <sub>dc</sub> )	160 to 250V	315 to 400V	420 & 450V
	tanδ (Max.)	0.15	0.15	0.20
Low Temperature Characteristics (Max. Impedance Ratio)	Rated voltage (V <sub>dc</sub> )	160 to 250V	315 to 400V	420 & 450V
	Z(-25°C)/Z(+20°C)	4	8	8
Endurance	The following specifications shall be satisfied when the capacitors are restored to 20°C after subjected to DC voltage with the rated ripple current is applied for 2,000 hours at 105°C.			
	Capacitance change	≤ ±20% of the initial value		
	D.F. (tanδ)	≤ 200% of the initial specified value		
	Leakage current	≤ The initial specified value		
Shelf Life	The following specifications shall be satisfied when the capacitors are restored to 20°C after exposing them for 1000 hours at 105°C without voltage applied.			
	Capacitance change	≤ ±15% of the initial value		
	D.F. (tanδ)	≤ 150% of the initial specified value		
	Leakage current	≤ The initial specified value		

## ◆ DIMENSIONS [mm]

● Terminal Code : VS (φ22 to φ35) : Standard

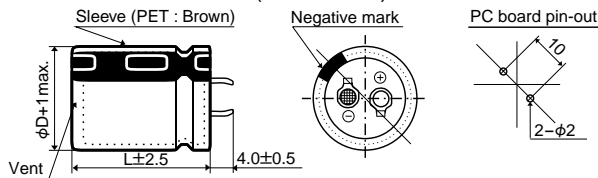

● Terminal Code : LI (φ35)

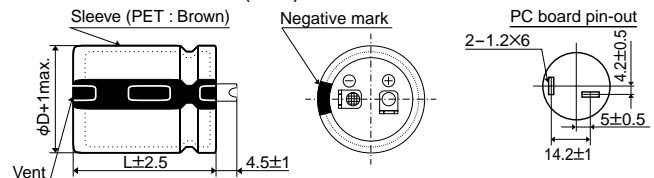

The standard design has no plastic disc.

## ◆ PART NUMBERING SYSTEM

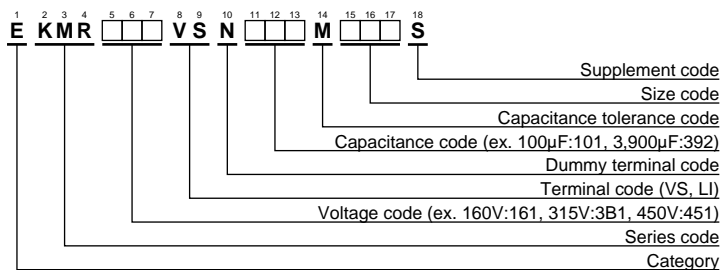

Please refer to "Product code guide (snap-in type)"



◆STANDARD RATINGS

WV (Vdc)	Cap (μF)	Case size φD×L(mm)	Rated ripple current (Arms/105°C, 120Hz)	Part No.	WV (Vdc)	Cap (μF)	Case size φD×L(mm)	Rated ripple current (Arms/105°C, 120Hz)	Part No.
160	560	22×25	1.58	EKMR161VSN561MP25S	200	2,200	35×40	2.92	EKMR201VSN222MA40S
	680	22×30	1.83	EKMR161VSN681MP30S		2,700	35×45	3.33	EKMR201VSN272MA45S
	820	22×35	2.06	EKMR161VSN821MP35S		2,700	35×50	3.43	EKMR201VSN272MA50S
	820	25.4×25	1.89	EKMR161VSN821MQ25S		330	22×25	1.21	EKMR251VSN331MP25S
	1,000	22×40	2.33	EKMR161VSN102MP40S		390	22×30	1.38	EKMR251VSN391MP30S
	1,000	25.4×30	2.15	EKMR161VSN102MQ30S		470	22×35	1.56	EKMR251VSN471MP35S
	1,000	30×25	1.90	EKMR161VSN102MR25S		560	22×40	1.74	EKMR251VSN561MP40S
	1,200	22×45	2.61	EKMR161VSN122MP45S		560	25.4×30	1.61	EKMR251VSN561MQ30S
	1,200	22×50	2.69	EKMR161VSN122MP50S		560	30×25	1.42	EKMR251VSN561MR25S
	1,200	25.4×35	2.45	EKMR161VSN122MQ35S		680	22×45	1.97	EKMR251VSN681MP45S
	1,500	25.4×40	2.82	EKMR161VSN152MQ40S		680	25.4×35	1.85	EKMR251VSN681MQ35S
	1,500	25.4×45	2.88	EKMR161VSN152MQ45S		820	25.4×40	2.08	EKMR251VSN821MQ40S
	1,500	30×30	2.39	EKMR161VSN152MR30S		820	25.4×45	2.13	EKMR251VSN821MQ45S
	1,500	35×25	2.17	EKMR161VSN152MA25S		820	30×30	1.77	EKMR251VSN821MR30S
	1,800	25.4×50	3.22	EKMR161VSN182MQ50S		820	35×25	1.60	EKMR251VSN821MA25S
	1,800	30×35	2.73	EKMR161VSN182MR35S		1,000	25.4×50	2.40	EKMR251VSN102MQ50S
	1,800	30×40	2.82	EKMR161VSN182MR40S		1,000	30×35	2.03	EKMR251VSN102MR35S
	1,800	35×30	2.47	EKMR161VSN182MA30S		1,200	30×40	2.31	EKMR251VSN122MR40S
	2,200	30×45	3.23	EKMR161VSN222MR45S		1,200	30×45	2.38	EKMR251VSN122MR45S
	2,200	35×35	2.79	EKMR161VSN222MA35S		1,200	35×35	2.06	EKMR251VSN122MA35S
2,700	30×50	3.66	EKMR161VSN272MR50S	1,500	30×50	2.73	EKMR251VSN152MR50S		
2,700	35×40	3.23	EKMR161VSN272MA40S	1,500	35×40	2.41	EKMR251VSN152MA40S		
3,300	35×45	3.68	EKMR161VSN332MA45S	1,800	35×45	2.72	EKMR251VSN182MA45S		
3,900	35×50	4.12	EKMR161VSN392MA50S	2,200	35×50	3.10	EKMR251VSN222MA50S		
180	470	22×25	1.45	EKMR181VSN471MP25S	315	180	22×25	0.91	EKMR3B1VSN181MP25S
	560	22×30	1.66	EKMR181VSN561MP30S		220	22×30	1.06	EKMR3B1VSN221MP30S
	680	22×35	1.87	EKMR181VSN681MP35S		270	22×35	1.20	EKMR3B1VSN271MP35S
	680	25.4×25	1.72	EKMR181VSN681MQ25S		270	25.4×25	1.15	EKMR3B1VSN271MP25S
	820	22×40	2.11	EKMR181VSN821MP40S		330	22×40	1.37	EKMR3B1VSN331MP40S
	820	25.4×30	1.94	EKMR181VSN821MQ30S		330	25.4×30	1.30	EKMR3B1VSN331MQ30S
	1,000	22×45	2.38	EKMR181VSN102MP45S		390	22×45	1.52	EKMR3B1VSN391MP45S
	1,000	25.4×35	2.24	EKMR181VSN102MQ35S		390	25.4×35	1.48	EKMR3B1VSN391MQ35S
	1,000	30×25	1.90	EKMR181VSN102MR25S		390	30×25	1.39	EKMR3B1VSN391MR25S
	1,200	22×50	2.69	EKMR181VSN122MP50S		470	22×50	1.72	EKMR3B1VSN471MP50S
	1,200	25.4×40	2.52	EKMR181VSN122MQ40S		470	25.4×40	1.67	EKMR3B1VSN471MQ40S
	1,200	30×30	2.14	EKMR181VSN122MR30S		470	30×30	1.57	EKMR3B1VSN471MR30S
	1,200	35×25	1.94	EKMR181VSN122MA25S		470	35×25	1.52	EKMR3B1VSN471MA25S
	1,500	25.4×45	2.88	EKMR181VSN152MQ45S		560	25.4×45	1.86	EKMR3B1VSN561MQ45S
	1,500	25.4×50	2.94	EKMR181VSN152MQ50S		560	30×35	1.78	EKMR3B1VSN561MR35S
	1,500	30×35	2.49	EKMR181VSN152MR35S		680	25.4×50	2.10	EKMR3B1VSN681MQ50S
	1,800	30×40	2.82	EKMR181VSN182MR40S		680	30×40	2.03	EKMR3B1VSN681MR40S
	1,800	35×30	2.47	EKMR181VSN182MA30S		680	35×30	1.90	EKMR3B1VSN681MA30S
	2,200	30×45	3.23	EKMR181VSN222MR45S		820	30×45	2.31	EKMR3B1VSN821MR45S
	2,200	30×50	3.31	EKMR181VSN222MR50S		820	35×35	2.13	EKMR3B1VSN821MA35S
2,200	35×35	2.79	EKMR181VSN222MA35S	1,000	30×50	2.61	EKMR3B1VSN102MR50S		
2,200	35×40	2.92	EKMR181VSN222MA40S	1,000	35×40	2.46	EKMR3B1VSN102MA40S		
2,700	35×45	3.33	EKMR181VSN272MA45S	1,200	35×45	2.78	EKMR3B1VSN122MA45S		
3,300	35×50	3.79	EKMR181VSN332MA50S	1,200	35×50	2.86	EKMR3B1VSN122MA50S		
200	560	22×30	1.66	EKMR201VSN561MP30S	350	150	22×25	0.84	EKMR351VSN151MP25S
	560	25.4×25	1.56	EKMR201VSN561MQ25S		220	22×30	1.06	EKMR351VSN221MP30S
	680	22×35	1.87	EKMR201VSN681MP35S		220	25.4×25	1.04	EKMR351VSN221MQ25S
	680	25.4×30	1.77	EKMR201VSN681MQ30S		270	22×35	1.20	EKMR351VSN271MP35S
	820	22×40	2.11	EKMR201VSN821MP40S		270	25.4×30	1.18	EKMR351VSN271MQ30S
	820	25.4×35	2.03	EKMR201VSN821MQ35S		330	22×40	1.37	EKMR351VSN331MP40S
	820	30×25	1.72	EKMR201VSN821MR25S		330	22×45	1.40	EKMR351VSN331MP45S
	1,000	22×50	2.45	EKMR201VSN102MP50S		330	25.4×35	1.36	EKMR351VSN331MQ35S
	1,000	25.4×40	2.30	EKMR201VSN102MQ40S		330	30×25	1.28	EKMR351VSN331MR25S
	1,000	30×30	1.95	EKMR201VSN102MR30S		390	22×50	1.56	EKMR351VSN391MP50S
	1,200	25.4×45	2.58	EKMR201VSN122MQ45S		390	25.4×40	1.52	EKMR351VSN391MQ40S
	1,200	30×35	2.23	EKMR201VSN122MR35S		390	30×30	1.43	EKMR351VSN391MR30S
	1,200	35×25	1.94	EKMR201VSN122MA25S		390	35×25	1.38	EKMR351VSN391MA25S
	1,500	25.4×50	2.94	EKMR201VSN152MQ50S		470	25.4×45	1.71	EKMR351VSN471MQ45S
	1,500	30×40	2.58	EKMR201VSN152MR40S		560	25.4×50	1.90	EKMR351VSN561MQ50S
	1,500	35×30	2.25	EKMR201VSN152MA30S		560	30×35	1.78	EKMR351VSN561MR35S
	1,800	30×45	2.92	EKMR201VSN182MR45S		560	30×40	1.84	EKMR351VSN561MR40S
	1,800	35×35	2.53	EKMR201VSN182MA35S		560	35×30	1.72	EKMR351VSN561MA30S
	2,200	30×50	3.31	EKMR201VSN222MR50S		680	30×45	2.10	EKMR351VSN681MR45S



◆STANDARD RATINGS

WV (Vdc)	Cap (μF)	Case size φD×L(mm)	Rated ripple current (Arms/105°C, 120Hz)	Part No.	WV (Vdc)	Cap (μF)	Case size φD×L(mm)	Rated ripple current (Arms/105°C, 120Hz)	Part No.
350	680	35×35	1.94	EKMR351VSN681MA35S	420	270	25.4×40	1.32	EKMR421VSN271MQ40S
	820	30×50	2.36	EKMR351VSN821MR50S		270	30×30	1.26	EKMR421VSN271MR30S
	820	35×40	2.23	EKMR351VSN821MA40S		270	35×25	1.26	EKMR421VSN271MA25S
	1,000	35×45	2.54	EKMR351VSN102MA45S		330	25.4×45	1.49	EKMR421VSN331MQ45S
	1,200	35×50	2.86	EKMR351VSN122MA50S		330	30×35	1.45	EKMR421VSN331MR35S
400	120	22×25	0.75	EKMR401VSN121MP25S		390	25.4×50	1.66	EKMR421VSN391MQ50S
	180	22×30	0.96	EKMR401VSN181MP30S		390	30×40	1.63	EKMR421VSN391MR40S
	180	25.4×25	0.94	EKMR401VSN181MQ25S		390	35×30	1.58	EKMR421VSN391MA30S
	220	22×35	1.09	EKMR401VSN221MP35S		470	30×45	1.85	EKMR421VSN471MR45S
	220	25.4×30	1.07	EKMR401VSN221MQ30S		470	35×35	1.77	EKMR421VSN471MA35S
	270	22×40	1.24	EKMR401VSN271MP40S		560	30×50	2.07	EKMR421VSN561MR50S
	270	22×45	1.26	EKMR401VSN271MP45S		560	35×40	2.02	EKMR421VSN561MA40S
	270	25.4×35	1.23	EKMR401VSN271MQ35S		680	35×45	2.29	EKMR421VSN681MA45S
	270	30×25	1.16	EKMR401VSN271MR25S		820	35×50	2.59	EKMR421VSN821MA50S
	330	22×50	1.44	EKMR401VSN331MP50S		450	100	22×25	0.71
	330	25.4×40	1.40	EKMR401VSN331MQ40S	120		22×30	0.82	EKMR451VSN121MP30S
	330	30×30	1.31	EKMR401VSN331MR30S	150		22×35	0.94	EKMR451VSN151MP35S
	330	35×25	1.27	EKMR401VSN331MA25S	150		25.4×25	0.89	EKMR451VSN151MQ25S
	390	25.4×45	1.55	EKMR401VSN391MR45S	180		22×40	1.05	EKMR451VSN181MP40S
	390	30×35	1.49	EKMR401VSN391MR35S	180		25.4×30	1.00	EKMR451VSN181MQ30S
	470	25.4×50	1.74	EKMR401VSN471MQ50S	220		22×45	1.19	EKMR451VSN221MP45S
	470	30×40	1.69	EKMR401VSN471MR40S	220		25.4×35	1.16	EKMR451VSN221MQ35S
	470	35×30	1.58	EKMR401VSN471MA30S	220		30×25	1.11	EKMR451VSN221MR25S
	560	30×45	1.91	EKMR401VSN561MR45S	270		22×50	1.36	EKMR451VSN271MP50S
	560	35×35	1.76	EKMR401VSN561MA35S	270		25.4×40	1.32	EKMR451VSN271MQ40S
	680	30×50	2.15	EKMR401VSN681MR50S	270		25.4×45	1.35	EKMR451VSN271MQ45S
680	35×40	2.03	EKMR401VSN681MA40S	270	30×30		1.26	EKMR451VSN271MR30S	
820	35×45	2.30	EKMR401VSN821MA45S	270	35×25		1.26	EKMR451VSN271MA25S	
820	35×50	2.37	EKMR401VSN821MA50S	330	25.4×50		1.52	EKMR451VSN331MQ50S	
420	120	22×25	0.78	EKMR421VSN121MP25S	330		30×35	1.45	EKMR451VSN331MR35S
	150	22×30	0.91	EKMR421VSN151MP30S	330		35×30	1.45	EKMR451VSN331MA30S
	150	25.4×25	0.89	EKMR421VSN151MQ25S	390		30×40	1.63	EKMR451VSN391MR40S
	180	22×35	1.03	EKMR421VSN181MP35S	470		30×45	1.85	EKMR451VSN471MR45S
	180	25.4×30	1.00	EKMR421VSN181MQ30S	470		30×50	1.90	EKMR451VSN471MR50S
	220	22×40	1.16	EKMR421VSN221MP40S	470		35×35	1.77	EKMR451VSN471MA35S
	220	22×45	1.19	EKMR421VSN221MP45S	560	35×40	2.02	EKMR451VSN561MA40S	
	220	25.4×35	1.16	EKMR421VSN221MQ35S	560	35×45	2.08	EKMR451VSN561MA45S	
	220	30×25	1.11	EKMR421VSN221MR25S	680	35×50	2.36	EKMR451VSN681MA50S	
	270	22×50	1.36	EKMR421VSN271MP50S					

◆RATED RIPPLE CURRENT MULTIPLIERS

●Frequency Multipliers

Frequency(Hz)	50	120	300	1k	10k	50k
160 to 250V <sub>dc</sub>	0.81	1.00	1.17	1.32	1.45	1.50
315 to 450V <sub>dc</sub>	0.77	1.00	1.16	1.30	1.41	1.43

The endurance of capacitors is reduced with internal heating produced by ripple current at the rate of halving the lifetime with every 5°C rise. When long life performance is required in actual use, the rms ripple current has to be reduced.

# SMQ Series

- Downsized from current downsized snap-ins SMH series
- Endurance with ripple current : 2,000 hours at 85°C
- Non solvent resistant type
- RoHS Compliant

SMQ

↑  
Downsized  
SMH



## ◆ SPECIFICATIONS

Items	Characteristics			
Category	-25 to +85°C			
Temperature Range	-25 to +85°C			
Rated Voltage Range	160 to 450V <sub>dc</sub>			
Capacitance Tolerance	±20% (M) (at 20°C, 120Hz)			
Leakage Current	I ≤ 3·C/V Where, I : Max. leakage current (µA), C : Nominal capacitance (µF), V : Rated voltage (V) (at 20°C after 5 minutes)			
Dissipation Factor (tanδ)	Rated voltage (V <sub>dc</sub> )	160 to 250V	315 to 400V	420 & 450V
	tanδ (Max.)	0.15	0.15	0.20
Low Temperature Characteristics (Max. Impedance Ratio)	Rated voltage (V <sub>dc</sub> )	160 to 250V	315 to 400V	420 & 450V
	Z(-25°C)/Z(+20°C)	4	8	8
Endurance	The following specifications shall be satisfied when the capacitors are restored to 20°C after subjected to DC voltage with the rated ripple current is applied for 2,000 hours at 85°C.			
	Capacitance change	≤ ±20% of the initial value		
	D.F. (tanδ)	≤ 200% of the initial specified value		
	Leakage current	≤ The initial specified value		
Shelf Life	The following specifications shall be satisfied when the capacitors are restored to 20°C after exposing them for 1,000 hours at 85°C without voltage applied.			
	Capacitance change	≤ ±15% of the initial value		
	D.F. (tanδ)	≤ 150% of the initial specified value		
	Leakage current	≤ The initial specified value		

## ◆ DIMENSIONS [mm]

● Terminal Code : VS (φ22 to φ35) : Standard

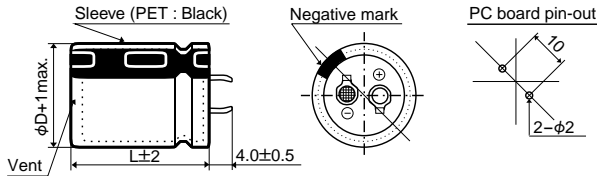

● Terminal Code : LI (φ35)

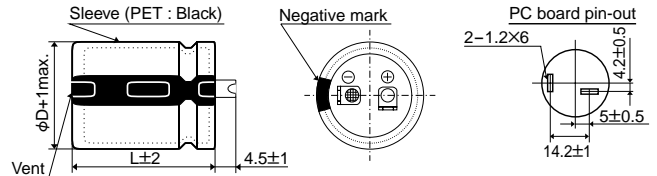

The standard design has no plastic disc.

## ◆ PART NUMBERING SYSTEM

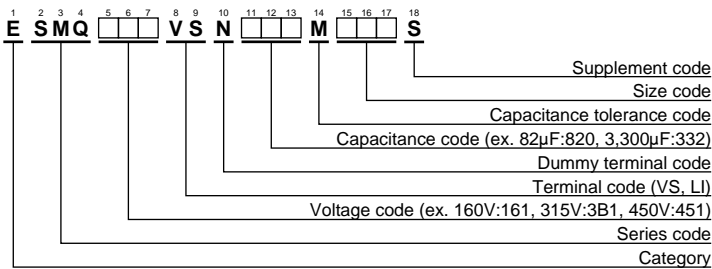

Please refer to "Product code guide (snap-in type)"

## ◆STANDARD RATINGS

WV (Vdc)	Cap (μF)	Case size φD×L(mm)	tanδ	Rated ripple current (Arms/85°C,120Hz)	Part No.
160	560	22×25	0.15	2.25	ESMQ161VSN561MP25S
	680	22×30	0.15	2.50	ESMQ161VSN681MP30S
	820	22×35	0.15	2.75	ESMQ161VSN821MP35S
	1,000	22×40	0.15	3.00	ESMQ161VSN102MP40S
	1,000	25.4×30	0.15	3.00	ESMQ161VSN102MQ30S
	1,200	22×45	0.15	3.25	ESMQ161VSN122MP45S
	1,200	25.4×35	0.15	3.25	ESMQ161VSN122MQ35S
	1,200	30×25	0.15	3.25	ESMQ161VSN122MR25S
	1,500	22×50	0.15	3.73	ESMQ161VSN152MP50S
	1,500	25.4×40	0.15	3.73	ESMQ161VSN152MQ40S
	1,500	30×30	0.15	3.73	ESMQ161VSN152MR30S
	1,500	35×25	0.15	3.73	ESMQ161VSN152MA25S
	1,800	25.4×45	0.15	4.20	ESMQ161VSN182MP45S
	1,800	30×35	0.15	4.20	ESMQ161VSN182MR35S
	1,800	35×30	0.15	4.20	ESMQ161VSN182MA30S
	2,200	30×40	0.15	4.78	ESMQ161VSN222MR40S
	2,200	35×35	0.15	4.78	ESMQ161VSN222MA35S
	2,700	35×40	0.15	5.45	ESMQ161VSN272MA40S
	3,300	35×45	0.15	5.75	ESMQ161VSN332MA45S
	3,900	35×50	0.15	6.00	ESMQ161VSN392MA50S
180	470	22×25	0.15	2.08	ESMQ181VSN471MP25S
	560	22×30	0.15	2.25	ESMQ181VSN561MP30S
	680	22×30	0.15	2.50	ESMQ181VSN681MP30S
	680	25.4×25	0.15	2.50	ESMQ181VSN681MQ25S
	820	22×35	0.15	2.75	ESMQ181VSN821MP35S
	820	25.4×30	0.15	2.75	ESMQ181VSN821MQ30S
	1,000	22×45	0.15	3.00	ESMQ181VSN102MP45S
	1,000	25.4×35	0.15	3.00	ESMQ181VSN102MQ35S
	1,000	30×25	0.15	3.00	ESMQ181VSN102MR25S
	1,200	22×50	0.15	3.31	ESMQ181VSN122MP50S
	1,200	25.4×40	0.15	3.31	ESMQ181VSN122MQ40S
	1,200	30×30	0.15	3.31	ESMQ181VSN122MR30S
	1,200	35×25	0.15	3.31	ESMQ181VSN122MA25S
	1,500	25.4×45	0.15	3.83	ESMQ181VSN152MP45S
	1,500	30×35	0.15	3.83	ESMQ181VSN152MR35S
	1,500	35×30	0.15	3.83	ESMQ181VSN152MA30S
	1,800	25.4×50	0.15	4.32	ESMQ181VSN182MQ50S
	1,800	30×40	0.15	4.32	ESMQ181VSN182MR40S
	1,800	35×30	0.15	4.32	ESMQ181VSN182MA30S
	2,200	30×45	0.15	4.92	ESMQ181VSN222MR45S
2,200	35×40	0.15	4.92	ESMQ181VSN222MA40S	
2,700	35×45	0.15	5.52	ESMQ181VSN272MA45S	
3,300	35×50	0.15	5.75	ESMQ181VSN332MA50S	
200	390	22×25	0.15	1.68	ESMQ201VSN391MP25S
	470	22×30	0.15	1.85	ESMQ201VSN471MP30S
	560	22×30	0.15	2.43	ESMQ201VSN561MP30S
	560	25.4×25	0.15	2.43	ESMQ201VSN561MQ25S
	680	22×35	0.15	2.68	ESMQ201VSN681MP35S
	680	25.4×30	0.15	2.68	ESMQ201VSN681MQ30S
	820	22×40	0.15	2.93	ESMQ201VSN821MP40S
	820	25.4×30	0.15	2.93	ESMQ201VSN821MQ30S
	820	30×25	0.15	2.93	ESMQ201VSN821MR25S
	1,000	22×45	0.15	3.25	ESMQ201VSN102MP45S
	1,000	25.4×35	0.15	3.25	ESMQ201VSN102MQ35S
	1,000	30×30	0.15	3.25	ESMQ201VSN102MR30S
	1,000	35×25	0.15	3.25	ESMQ201VSN102MA25S
	1,200	25.4×40	0.15	3.50	ESMQ201VSN122MQ40S
	1,200	30×30	0.15	3.50	ESMQ201VSN122MR30S
	1,200	35×30	0.15	3.50	ESMQ201VSN122MA30S
	1,500	25.4×50	0.15	3.87	ESMQ201VSN152MQ50S
	1,500	30×35	0.15	3.87	ESMQ201VSN152MR35S
	1,500	35×30	0.15	3.87	ESMQ201VSN152MA30S
	1,800	30×45	0.15	4.32	ESMQ201VSN182MR45S
1,800	35×35	0.15	4.32	ESMQ201VSN182MA35S	
2,200	30×50	0.15	4.92	ESMQ201VSN222MR50S	
2,200	35×40	0.15	4.92	ESMQ201VSN222MA40S	
2,700	35×50	0.15	5.45	ESMQ201VSN272MA50S	
250	270	22×25	0.15	1.31	ESMQ251VSN271MP25S
	330	22×30	0.15	1.75	ESMQ251VSN331MP30S
	390	22×30	0.15	1.91	ESMQ251VSN391MP30S
	390	25.4×25	0.15	1.91	ESMQ251VSN391MQ25S
	470	22×35	0.15	2.11	ESMQ251VSN471MP35S
	470	25.4×30	0.15	2.11	ESMQ251VSN471MQ30S
	560	22×40	0.15	2.25	ESMQ251VSN561MP40S
	560	25.4×30	0.15	2.25	ESMQ251VSN561MQ30S
	560	30×25	0.15	2.25	ESMQ251VSN561MR25S
	680	22×45	0.15	2.50	ESMQ251VSN681MP45S
	680	25.4×35	0.15	2.50	ESMQ251VSN681MQ35S
	680	30×30	0.15	2.50	ESMQ251VSN681MR30S
	820	22×50	0.15	2.77	ESMQ251VSN821MP50S
	820	25.4×40	0.15	2.77	ESMQ251VSN821MQ40S
	820	30×30	0.15	2.77	ESMQ251VSN821MR30S
	820	35×25	0.15	2.77	ESMQ251VSN821MA25S
	1,000	25.4×45	0.15	3.32	ESMQ251VSN102MQ45S
	1,000	30×35	0.15	3.32	ESMQ251VSN102MR35S
	1,000	35×30	0.15	3.32	ESMQ251VSN102MA30S
	1,200	30×40	0.15	3.53	ESMQ251VSN122MR40S
1,200	35×35	0.15	3.53	ESMQ251VSN122MA35S	
1,500	30×50	0.15	4.04	ESMQ251VSN152MR50S	
1,500	35×40	0.15	4.04	ESMQ251VSN152MA40S	
1,800	35×45	0.15	4.55	ESMQ251VSN182MA45S	
315	180	22×25	0.15	1.21	ESMQ315VSN181MP25S
	220	22×30	0.15	1.41	ESMQ315VSN221MP30S
	270	22×30	0.15	1.60	ESMQ315VSN271MP30S
	330	22×40	0.15	1.82	ESMQ315VSN331MP40S
	330	25.4×30	0.15	1.82	ESMQ315VSN331MQ30S
	330	30×25	0.15	1.82	ESMQ315VSN331MR25S
	390	22×45	0.15	2.01	ESMQ315VSN391MP45S
	390	25.4×35	0.15	2.01	ESMQ315VSN391MQ35S
	390	30×30	0.15	2.01	ESMQ315VSN391MR30S
	470	22×50	0.15	2.27	ESMQ315VSN471MP50S
	470	25.4×40	0.15	2.27	ESMQ315VSN471MQ40S
	470	30×30	0.15	2.27	ESMQ315VSN471MR30S
	470	35×25	0.15	2.27	ESMQ315VSN471MA25S
	560	25.4×45	0.15	2.56	ESMQ315VSN561MQ45S
	560	30×35	0.15	2.56	ESMQ315VSN561MR35S
	560	35×30	0.15	2.56	ESMQ315VSN561MA30S
	680	30×40	0.15	2.87	ESMQ315VSN681MR40S
	680	35×35	0.15	2.87	ESMQ315VSN681MA35S
	820	30×45	0.15	3.25	ESMQ315VSN821MR45S
	820	35×40	0.15	3.25	ESMQ315VSN821MA40S
1,000	30×50	0.15	3.63	ESMQ315VSN102MR50S	
1,000	35×45	0.15	3.63	ESMQ315VSN102MA45S	
350	150	22×25	0.15	1.12	ESMQ351VSN151MP25S
	180	22×30	0.15	1.22	ESMQ351VSN181MP30S
	220	22×35	0.15	1.44	ESMQ351VSN221MP35S
	270	22×40	0.15	1.66	ESMQ351VSN271MP40S
	270	25.4×30	0.15	1.66	ESMQ351VSN271MQ30S
	330	22×45	0.15	1.88	ESMQ351VSN331MP45S
	330	25.4×35	0.15	1.88	ESMQ351VSN331MQ35S
	390	22×50	0.15	2.06	ESMQ351VSN391MP50S
	390	25.4×40	0.15	2.06	ESMQ351VSN391MQ40S
	390	30×30	0.15	2.06	ESMQ351VSN391MR30S
	390	35×25	0.15	2.06	ESMQ351VSN391MA25S
	470	25.4×45	0.15	2.40	ESMQ351VSN471MQ45S
	470	30×35	0.15	2.40	ESMQ351VSN471MR35S
	470	35×30	0.15	2.40	ESMQ351VSN471MA30S
	560	25.4×50	0.15	2.60	ESMQ351VSN561MQ50S
	560	30×40	0.15	2.60	ESMQ351VSN561MR40S
	560	35×30	0.15	2.60	ESMQ351VSN561MA30S
	680	30×45	0.15	2.96	ESMQ351VSN681MR45S
	680	35×35	0.15	2.96	ESMQ351VSN681MA35S
	820	30×50	0.15	3.25	ESMQ351VSN821MR50S
820	35×45	0.15	3.25	ESMQ351VSN821MA45S	

## ◆STANDARD RATINGS

WV (Vdc)	Cap (μF)	Case size φD×L(mm)	tanδ	Rated ripple current (Arms/85°C,120Hz)	Part No.	WV (Vdc)	Cap (μF)	Case size φD×L(mm)	tanδ	Rated ripple current (Arms/85°C,120Hz)	Part No.	
350	1,000	35×50	0.15	3.54	ESMQ351VSN102MA50S	420	270	30×30	0.20	1.94	ESMQ421VSN271MR30S	
400	120	22×25	0.15	1.02	ESMQ401VSN121MP25S		330	25.4×45	0.20	2.17	ESMQ421VSN331MQ45S	
	150	22×30	0.15	1.16	ESMQ401VSN151MP30S		330	30×35	0.20	2.17	ESMQ421VSN331MR35S	
	180	22×35	0.15	1.44	ESMQ401VSN181MP35S		330	35×30	0.20	2.17	ESMQ421VSN331MA30S	
	220	22×40	0.15	1.49	ESMQ401VSN221MP40S		390	25.4×50	0.20	2.27	ESMQ421VSN391MQ50S	
	220	25.4×30	0.15	1.49	ESMQ401VSN221MQ30S		390	30×35	0.20	2.27	ESMQ421VSN391MR35S	
	270	22×45	0.15	1.67	ESMQ401VSN271MP45S		390	35×30	0.20	2.27	ESMQ421VSN391MA30S	
	270	25.4×35	0.15	1.67	ESMQ401VSN271MQ35S		470	30×40	0.20	2.61	ESMQ421VSN471MR40S	
	270	30×25	0.15	1.67	ESMQ401VSN271MP25S		470	35×35	0.20	2.61	ESMQ421VSN471MA35S	
	330	22×50	0.15	1.90	ESMQ401VSN331MP50S		560	30×50	0.20	2.82	ESMQ421VSN561MR50S	
	330	25.4×40	0.15	1.90	ESMQ401VSN331MQ40S		560	35×40	0.20	2.82	ESMQ421VSN561MA40S	
	330	30×30	0.15	1.90	ESMQ401VSN331MR30S		680	35×45	0.20	3.11	ESMQ421VSN681MA45S	
	330	35×25	0.15	1.90	ESMQ401VSN331MA25S		450	82	22×25	0.20	0.83	ESMQ451VSN820MP25S
	390	25.4×45	0.15	2.13	ESMQ401VSN391MQ45S			100	22×25	0.20	0.93	ESMQ451VSN101MP25S
	390	30×35	0.15	2.13	ESMQ401VSN391MR35S			120	22×30	0.20	1.04	ESMQ451VSN121MP30S
	390	35×30	0.15	2.13	ESMQ401VSN391MA30S			150	22×35	0.20	1.19	ESMQ451VSN151MP35S
470	25.4×50	0.15	2.39	ESMQ401VSN471MQ50S	150	25.4×25		0.20	1.19	ESMQ451VSN151MQ25S		
470	30×40	0.15	2.39	ESMQ401VSN471MR40S	180	22×40		0.20	1.35	ESMQ451VSN181MP40S		
470	35×30	0.15	2.39	ESMQ401VSN471MA30S	180	25.4×30		0.20	1.35	ESMQ451VSN181MQ30S		
560	30×45	0.15	2.69	ESMQ401VSN561MR45S	220	22×45		0.20	1.55	ESMQ451VSN221MP45S		
560	35×35	0.15	2.69	ESMQ401VSN561MA35S	220	25.4×40		0.20	1.55	ESMQ451VSN221MQ40S		
680	30×50	0.15	2.96	ESMQ401VSN681MR50S	220	30×30		0.20	1.55	ESMQ451VSN221MR30S		
680	35×40	0.15	2.96	ESMQ401VSN681MA40S	220	35×25		0.20	1.55	ESMQ451VSN221MA25S		
820	35×45	0.15	3.25	ESMQ401VSN821MA45S	270	22×50		0.20	1.78	ESMQ451VSN271MP50S		
420	100	22×25	0.20	0.97	ESMQ421VSN101MP25S	270		25.4×40	0.20	1.78	ESMQ451VSN271MQ40S	
	120	22×25	0.20	1.08	ESMQ421VSN121MP25S	270		30×30	0.20	1.78	ESMQ451VSN271MR30S	
	150	22×30	0.20	1.30	ESMQ421VSN151MP30S	330		25.4×50	0.20	2.01	ESMQ451VSN331MQ50S	
	150	25.4×25	0.20	1.30	ESMQ421VSN151MQ25S	330		30×40	0.20	2.01	ESMQ451VSN331MR40S	
	180	22×35	0.20	1.48	ESMQ421VSN181MP35S	330	35×30	0.20	2.01	ESMQ451VSN331MA30S		
	180	25.4×30	0.20	1.48	ESMQ421VSN181MQ30S	390	30×40	0.20	2.24	ESMQ451VSN391MR40S		
	220	22×40	0.20	1.65	ESMQ421VSN221MP40S	390	35×35	0.20	2.24	ESMQ451VSN391MA35S		
	220	25.4×35	0.20	1.65	ESMQ421VSN221MQ35S	470	30×45	0.20	2.53	ESMQ451VSN471MR45S		
	220	30×25	0.20	1.65	ESMQ421VSN221MR25S	470	35×40	0.20	2.53	ESMQ451VSN471MA40S		
	270	22×50	0.20	1.94	ESMQ421VSN271MP50S	560	30×50	0.20	2.82	ESMQ451VSN561MR50S		
	270	25.4×35	0.20	1.94	ESMQ421VSN271MQ35S	560	35×45	0.20	2.82	ESMQ451VSN561MA45S		

## ◆RATED RIPPLE CURRENT MULTIPLIERS

### ●Frequency Multipliers

Frequency(Hz)	50	120	300	1k	10k	50k
160 to 250V <sub>dc</sub>	0.81	1.00	1.17	1.32	1.45	1.50
315 to 450V <sub>dc</sub>	0.77	1.00	1.16	1.30	1.41	1.43

The endurance of capacitors is reduced with internal heating produced by ripple current at the rate of halving the lifetime with every 5°C rise. When long life performance is required in actual use, the rms ripple current has to be reduced.

# KMQ Series

- Downsized from current downsized snap-ins KMH series
- Endurance with ripple current : 2,000 hours at 105°C
- Non solvent resistant type
- RoHS Compliant

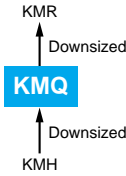

## ◆ SPECIFICATIONS

Items	Characteristics										
Category	Temperature Range										
Temperature Range	-40 to +105°C (35&50V <sub>dc</sub> ), -25 to +105°C (160 to 450V <sub>dc</sub> )										
Rated Voltage Range	35&50V <sub>dc</sub> , 160 to 450V <sub>dc</sub>										
Capacitance Tolerance	±20% (M) (at 20°C, 120Hz)										
Leakage Current	I ≤ 3·C·V Where, I : Max. leakage current (µA), C : Nominal capacitance (µF), V : Rated voltage (V) (at 20°C after 5 minutes)										
Dissipation Factor (tanδ)	Rated voltage (V <sub>dc</sub> )	35V		50V		160 to 250V		315 to 400V		420 & 450V	
	Nominal capacitance (µF)	10,000>C	C ≥ 10,000		10,000>C	C ≥ 10,000		—		—	
	tanδ (Max.)	0.30	0.35		0.25	0.30		0.15		0.15	
Low Temperature Characteristics (Max. Impedance Ratio)	Rated voltage (V <sub>dc</sub> )	35&50V		160 to 250V		315 to 400V		420 & 450V			
	Z(-40°C)/Z(+20°C)	4		—		—		—			
	Z(-25°C)/Z(+20°C)	10		4		8		8		(at 120Hz)	
Endurance	The following specifications shall be satisfied when the capacitors are restored to 20°C after subjected to DC voltage with the rated ripple current is applied for 2,000 hours at 105°C.										
	Capacitance change	≤ ±20% of the initial value									
	D.F. (tanδ)	≤ 200% of the initial specified value									
	Leakage current	≤ The initial specified value									
Shelf Life	The following specifications shall be satisfied when the capacitors are restored to 20°C after exposing them for 1,000 hours at 105°C without voltage applied.										
	Capacitance change	≤ ±15% of the initial value									
	D.F. (tanδ)	≤ 150% of the initial specified value									
	Leakage current	≤ The initial specified value									

## ◆ DIMENSIONS [mm]

● Terminal Code : VS (φ22 to φ35) : Standard

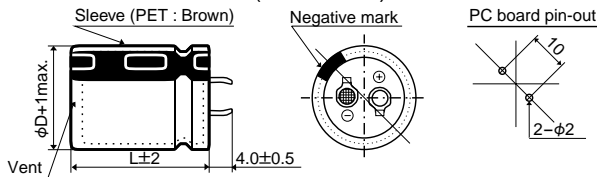

● Terminal Code : LI (φ35)

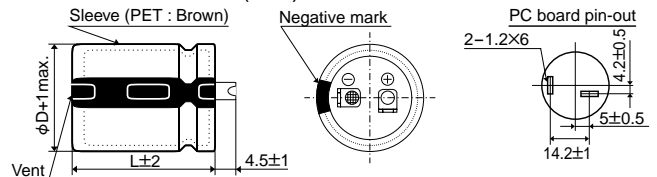

The standard design has no plastic disc.

## ◆ PART NUMBERING SYSTEM

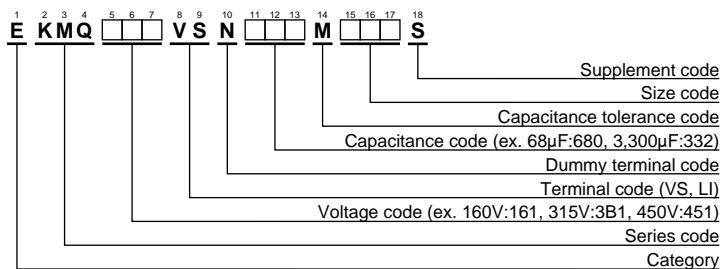

Please refer to "Product code guide (snap-in type)"



### ◆STANDARD RATINGS

WV (Vdc)	Cap (μF)	Case size φD×L(mm)	tanδ	Rated ripple current (Arms/105°C,120Hz)	Part No.	WV (Vdc)	Cap (μF)	Case size φD×L(mm)	tanδ	Rated ripple current (Arms/105°C,120Hz)	Part No.
35	4,700	22×25	0.30	1.87	EKMQ350VSN472MP25S	160	1,800	30×40	0.15	2.70	EKMQ161VSN182MR40S
	5,600	22×25	0.30	2.04	EKMQ350VSN562MP25S		1,800	35×30	0.15	2.70	EKMQ161VSN182MA30S
	5,600	25.4×25	0.30	2.00	EKMQ350VSN562MQ25S		2,200	30×45	0.15	2.90	EKMQ161VSN222MR45S
	6,800	22×30	0.30	2.36	EKMQ350VSN682MP30S		2,200	35×35	0.15	2.90	EKMQ161VSN222MA35S
	6,800	25.4×25	0.30	2.21	EKMQ350VSN682MQ25S		2,700	30×50	0.15	3.10	EKMQ161VSN272MR50S
	8,200	22×35	0.30	2.65	EKMQ350VSN822MP35S		2,700	35×40	0.15	3.10	EKMQ161VSN272MA40S
	8,200	25.4×30	0.30	2.49	EKMQ350VSN822MQ30S		3,300	35×50	0.15	3.30	EKMQ161VSN332MA50S
	8,200	30×25	0.30	2.62	EKMQ350VSN822MR25S		390	22×25	0.15	1.30	EKMQ181VSN391MP25S
	10,000	22×40	0.35	3.00	EKMQ350VSN103MP40S		470	22×30	0.15	1.40	EKMQ181VSN471MP30S
	10,000	25.4×35	0.35	2.88	EKMQ350VSN103MQ35S		560	22×30	0.15	1.50	EKMQ181VSN561MP30S
	10,000	30×25	0.35	2.90	EKMQ350VSN103MA25S		560	25.4×25	0.15	1.50	EKMQ181VSN102MR25S
	12,000	22×50	0.35	3.47	EKMQ350VSN123MP50S		680	22×35	0.15	1.70	EKMQ181VSN681MP35S
	12,000	25.4×35	0.35	3.15	EKMQ350VSN123MQ35S		680	25.4×30	0.15	1.70	EKMQ181VSN681MQ30S
	12,000	30×30	0.35	3.25	EKMQ350VSN123MR30S		820	22×40	0.15	2.00	EKMQ181VSN821MP40S
	12,000	35×25	0.35	3.20	EKMQ350VSN123MA25S		820	25.4×30	0.15	2.00	EKMQ181VSN821MQ30S
	15,000	25.4×40	0.35	3.61	EKMQ350VSN153MQ40S		820	30×25	0.15	2.00	EKMQ181VSN821MR25S
	15,000	30×35	0.35	3.78	EKMQ350VSN153MR35S		1,000	22×45	0.15	2.20	EKMQ181VSN102MP45S
	15,000	35×25	0.35	3.60	EKMQ350VSN153MA25S		1,000	25.4×40	0.15	2.20	EKMQ181VSN102MQ40S
	18,000	25.4×50	0.35	4.14	EKMQ350VSN183MQ50S		1,000	30×30	0.15	2.20	EKMQ181VSN102MR30S
	18,000	30×40	0.35	4.30	EKMQ350VSN183MR40S		1,000	35×25	0.15	2.20	EKMQ181VSN102MA25S
18,000	35×30	0.35	4.10	EKMQ350VSN183MA30S	1,200	25.4×45	0.15	2.30	EKMQ181VSN122MQ45S		
22,000	30×50	0.35	5.00	EKMQ350VSN223MR50S	1,200	30×35	0.15	2.30	EKMQ181VSN122MR35S		
22,000	35×35	0.35	4.64	EKMQ350VSN223MA35S	1,200	35×30	0.15	2.30	EKMQ181VSN122MA30S		
27,000	35×40	0.35	5.37	EKMQ350VSN273MA40S	1,500	25.4×50	0.15	2.50	EKMQ181VSN152MQ50S		
33,000	35×50	0.35	6.00	EKMQ350VSN333MA50S	1,500	30×40	0.15	2.50	EKMQ181VSN152MR40S		
50	2,700	22×25	0.25	1.65	EKMQ500VSN272MP25S	1,500	35×30	0.15	2.50	EKMQ181VSN152MA30S	
	3,300	22×30	0.25	1.92	EKMQ500VSN332MP30S	1,800	30×45	0.15	2.70	EKMQ181VSN182MR45S	
	3,300	25.4×25	0.25	1.76	EKMQ500VSN332MQ25S	1,800	35×35	0.15	2.70	EKMQ181VSN182MA35S	
	3,900	22×30	0.25	2.08	EKMQ500VSN392MP30S	2,200	30×50	0.15	2.90	EKMQ181VSN222MR50S	
	3,900	25.4×25	0.25	2.04	EKMQ500VSN392MQ25S	2,200	35×40	0.15	2.90	EKMQ181VSN222MA40S	
	4,700	22×35	0.25	2.43	EKMQ500VSN472MP35S	2,700	35×50	0.15	3.10	EKMQ181VSN272MA50S	
	4,700	25.4×30	0.25	2.50	EKMQ500VSN472MQ30S	390	22×25	0.15	1.31	EKMQ201VSN391MP25S	
	4,700	30×25	0.25	2.29	EKMQ500VSN472MR25S	470	22×30	0.15	1.45	EKMQ201VSN471MP30S	
	5,600	22×40	0.25	2.63	EKMQ500VSN562MP40S	560	22×30	0.15	1.67	EKMQ201VSN561MP30S	
	5,600	25.4×35	0.25	2.61	EKMQ500VSN562MQ35S	560	25.4×25	0.15	1.67	EKMQ201VSN561MQ25S	
	5,600	30×25	0.25	2.80	EKMQ500VSN562MR25S	680	22×40	0.15	1.75	EKMQ201VSN681MP40S	
	6,800	22×50	0.25	3.05	EKMQ500VSN682MP50S	680	25.4×30	0.15	1.75	EKMQ201VSN681MQ30S	
	6,800	25.4×40	0.25	2.94	EKMQ500VSN682MQ40S	820	22×45	0.15	2.04	EKMQ201VSN821MP45S	
	6,800	30×30	0.25	3.30	EKMQ500VSN682MR30S	820	25.4×35	0.15	2.04	EKMQ201VSN821MQ35S	
	6,800	35×25	0.25	2.77	EKMQ500VSN682MA25S	820	30×25	0.15	2.04	EKMQ201VSN821MR25S	
	8,200	25.4×45	0.25	3.60	EKMQ500VSN822MQ45S	1,000	22×50	0.15	2.30	EKMQ201VSN102MP50S	
	8,200	30×35	0.25	3.60	EKMQ500VSN822MR35S	1,000	25.4×45	0.15	2.30	EKMQ201VSN102MQ45S	
	8,200	35×30	0.25	3.60	EKMQ500VSN822MA30S	1,000	30×30	0.15	2.30	EKMQ201VSN102MR30S	
	10,000	25.4×50	0.30	4.00	EKMQ500VSN103MQ50S	1,000	35×25	0.15	2.30	EKMQ201VSN102MA25S	
	10,000	30×40	0.30	4.00	EKMQ500VSN103MR40S	1,200	25.4×50	0.15	2.65	EKMQ201VSN122MQ50S	
10,000	35×30	0.30	4.00	EKMQ500VSN103MA30S	1,200	30×35	0.15	2.65	EKMQ201VSN122MR35S		
12,000	30×50	0.30	4.29	EKMQ500VSN123MR50S	1,200	35×30	0.15	2.65	EKMQ201VSN122MA30S		
12,000	35×35	0.30	4.37	EKMQ500VSN123MA35S	1,500	30×40	0.15	2.80	EKMQ201VSN152MR40S		
15,000	35×40	0.30	4.50	EKMQ500VSN153MA40S	1,500	35×30	0.15	2.80	EKMQ201VSN152MA30S		
18,000	35×50	0.30	5.30	EKMQ500VSN183MA50S	1,800	30×45	0.15	3.08	EKMQ201VSN182MR45S		
160	470	22×25	0.15	1.40	EKMQ161VSN471MP25S	1,800	35×40	0.15	3.08	EKMQ201VSN182MA40S	
	560	22×30	0.15	1.50	EKMQ161VSN561MP30S	2,200	35×45	0.15	3.48	EKMQ201VSN222MA45S	
	680	22×30	0.15	1.70	EKMQ161VSN681MP30S	220	22×25	0.15	1.00	EKMQ251VSN221MP25S	
	680	25.4×25	0.15	1.70	EKMQ161VSN681MQ25S	270	22×25	0.15	1.10	EKMQ251VSN271MP25S	
	820	22×35	0.15	2.00	EKMQ161VSN821MP35S	330	22×30	0.15	1.20	EKMQ251VSN331MP30S	
	820	25.4×30	0.15	2.00	EKMQ161VSN821MQ30S	330	25.4×25	0.15	1.20	EKMQ251VSN331MQ25S	
	820	30×25	0.15	2.00	EKMQ161VSN821MR25S	390	22×35	0.15	1.30	EKMQ251VSN391MP35S	
	1,000	22×40	0.15	2.20	EKMQ161VSN102MP40S	390	25.4×25	0.15	1.30	EKMQ251VSN391MQ25S	
	1,000	25.4×35	0.15	2.20	EKMQ161VSN102MQ35S	470	22×40	0.15	1.40	EKMQ251VSN471MP40S	
	1,000	30×25	0.15	2.20	EKMQ161VSN102MR25S	470	25.4×30	0.15	1.40	EKMQ251VSN471MQ30S	
	1,200	25.4×40	0.15	2.30	EKMQ161VSN122MQ40S	470	30×25	0.15	1.40	EKMQ251VSN471MR25S	
	1,200	30×30	0.15	2.30	EKMQ161VSN122MR30S	560	22×45	0.15	1.50	EKMQ251VSN561MP45S	
	1,200	35×25	0.15	2.30	EKMQ161VSN122MA25S	560	25.4×35	0.15	1.50	EKMQ251VSN561MQ35S	
	1,500	25.4×45	0.15	2.50	EKMQ161VSN152MQ45S	560	30×25	0.15	1.50	EKMQ251VSN561MR25S	
	1,500	30×35	0.15	2.50	EKMQ161VSN152MR35S	680	22×50	0.15	1.70	EKMQ251VSN681MP50S	
	1,500	35×30	0.15	2.50	EKMQ161VSN152MA30S	680	25.4×40	0.15	1.70	EKMQ251VSN681MQ40S	
	1,800	25.4×50	0.15	2.70	EKMQ161VSN182MQ50S	680	30×30	0.15	1.70	EKMQ251VSN681MR30S	





◆STANDARD RATINGS

WV (Vdc)	Cap (μF)	Case size φD×L(mm)	tanδ	Rated ripple current (Arms/105°C,120Hz)	Part No.	WV (Vdc)	Cap (μF)	Case size φD×L(mm)	tanδ	Rated ripple current (Arms/105°C,120Hz)	Part No.
250	680	35×25	0.15	1.70	EKMQ251VSN681MA25S	400	270	25.4×40	0.15	1.22	EKMQ401VSN271MQ40S
	820	25.4×45	0.15	2.00	EKMQ251VSN821MQ45S		270	30×30	0.15	1.22	EKMQ401VSN271MR30S
	820	30×35	0.15	2.00	EKMQ251VSN821MR35S		270	35×25	0.15	1.22	EKMQ401VSN271MA25S
	820	35×30	0.15	2.00	EKMQ251VSN821MA30S		330	25.4×45	0.15	1.44	EKMQ401VSN331MQ45S
	1,000	30×40	0.15	2.20	EKMQ251VSN102MR40S		330	30×35	0.15	1.44	EKMQ401VSN331MR35S
	1,000	35×30	0.15	2.20	EKMQ251VSN102MA30S		330	35×30	0.15	1.44	EKMQ401VSN331MA30S
	1,200	30×45	0.15	2.30	EKMQ251VSN122MR45S		390	25.4×50	0.15	1.55	EKMQ401VSN391MQ50S
	1,200	35×35	0.15	2.30	EKMQ251VSN122MA35S		390	30×40	0.15	1.55	EKMQ401VSN391MR40S
	1,500	35×45	0.15	2.50	EKMQ251VSN152MA45S		390	35×30	0.15	1.55	EKMQ401VSN391MA30S
	1,800	35×50	0.15	2.70	EKMQ251VSN182MA50S		470	30×45	0.15	1.68	EKMQ401VSN471MR45S
315	150	22×25	0.15	0.82	EKMQ3B1VSN151MP25S	470	35×35	0.15	1.68	EKMQ401VSN471MA35S	
	180	22×30	0.15	0.90	EKMQ3B1VSN181MP30S	560	30×50	0.15	1.90	EKMQ401VSN561MR50S	
	220	22×30	0.15	1.00	EKMQ3B1VSN221MR30S	560	35×40	0.15	1.90	EKMQ401VSN561MA40S	
	220	25.4×25	0.15	1.00	EKMQ3B1VSN221MQ25S	680	35×45	0.15	2.12	EKMQ401VSN681MA45S	
	270	22×35	0.15	1.10	EKMQ3B1VSN271MP35S	82	22×25	0.20	0.64	EKMQ421VSN820MP25S	
	270	25.4×30	0.15	1.10	EKMQ3B1VSN271MQ30S	100	22×25	0.20	0.66	EKMQ421VSN101MP25S	
	330	22×45	0.15	1.20	EKMQ3B1VSN331MP45S	100	25.4×25	0.20	0.66	EKMQ421VSN101MQ25S	
	330	25.4×35	0.15	1.20	EKMQ3B1VSN331MQ35S	120	22×30	0.20	0.81	EKMQ421VSN121MP30S	
	330	30×25	0.15	1.20	EKMQ3B1VSN331MR25S	120	25.4×25	0.20	0.81	EKMQ421VSN121MQ25S	
	390	22×45	0.15	1.30	EKMQ3B1VSN391MP45S	150	22×35	0.20	0.84	EKMQ421VSN151MP35S	
	390	25.4×40	0.15	1.30	EKMQ3B1VSN391MQ40S	150	25.4×30	0.20	0.84	EKMQ421VSN151MQ30S	
	390	30×30	0.15	1.30	EKMQ3B1VSN391MR30S	150	30×25	0.20	0.84	EKMQ421VSN151MR25S	
	390	35×25	0.15	1.30	EKMQ3B1VSN391MA25S	180	22×40	0.20	0.91	EKMQ421VSN181MP40S	
	470	25.4×45	0.15	1.40	EKMQ3B1VSN471MQ45S	180	25.4×30	0.20	0.91	EKMQ421VSN181MQ30S	
	470	30×35	0.15	1.40	EKMQ3B1VSN471MR35S	180	30×25	0.20	0.91	EKMQ421VSN181MR25S	
	470	35×25	0.15	1.40	EKMQ3B1VSN471MA25S	220	22×45	0.20	1.05	EKMQ421VSN221MP45S	
	560	25.4×50	0.15	1.50	EKMQ3B1VSN561MQ50S	220	25.4×35	0.20	1.05	EKMQ421VSN221MQ35S	
	560	30×40	0.15	1.50	EKMQ3B1VSN561MR40S	220	30×30	0.20	1.05	EKMQ421VSN221MR30S	
	560	35×30	0.15	1.50	EKMQ3B1VSN561MA30S	220	35×25	0.20	1.05	EKMQ421VSN221MA25S	
	680	30×45	0.15	1.70	EKMQ3B1VSN681MR45S	270	25.4×40	0.20	1.25	EKMQ421VSN271MQ40S	
680	35×35	0.15	1.70	EKMQ3B1VSN681MA35S	270	30×30	0.20	1.25	EKMQ421VSN271MR30S		
820	30×50	0.15	2.00	EKMQ3B1VSN821MR50S	270	35×25	0.20	1.25	EKMQ421VSN271MA25S		
820	35×40	0.15	2.00	EKMQ3B1VSN821MA40S	330	25.4×50	0.20	1.42	EKMQ421VSN331MQ50S		
1,000	35×45	0.15	2.30	EKMQ3B1VSN102MA45S	330	30×35	0.20	1.42	EKMQ421VSN331MR35S		
350	120	22×25	0.15	0.75	EKMQ351VSN121MP25S	330	35×30	0.20	1.42	EKMQ421VSN331MA30S	
	150	22×30	0.15	0.82	EKMQ351VSN151MP30S	390	30×40	0.20	1.61	EKMQ421VSN391MR40S	
	180	22×30	0.15	0.90	EKMQ351VSN181MP30S	390	35×35	0.20	1.61	EKMQ421VSN391MA35S	
	180	25.4×25	0.15	0.90	EKMQ351VSN181MQ25S	470	30×45	0.20	1.86	EKMQ421VSN471MR45S	
	220	22×35	0.15	1.00	EKMQ351VSN221MP35S	470	35×40	0.20	1.86	EKMQ421VSN471MA40S	
	220	25.4×30	0.15	1.00	EKMQ351VSN221MQ30S	560	35×45	0.20	2.10	EKMQ421VSN561MA45S	
	270	22×40	0.15	1.10	EKMQ351VSN271MP40S	680	35×50	0.20	2.20	EKMQ421VSN681MA50S	
	270	25.4×30	0.15	1.10	EKMQ351VSN271MQ30S	68	22×25	0.20	0.50	EKMQ451VSN680MP25S	
	270	30×25	0.15	1.10	EKMQ351VSN271MR25S	82	22×30	0.20	0.56	EKMQ451VSN820MP30S	
	330	22×45	0.15	1.20	EKMQ351VSN331MP45S	100	22×30	0.20	0.64	EKMQ451VSN101MP30S	
	330	25.4×40	0.15	1.20	EKMQ351VSN331MQ40S	100	25.4×25	0.20	0.64	EKMQ451VSN101MQ25S	
	330	30×30	0.15	1.20	EKMQ351VSN331MR30S	120	22×35	0.20	0.72	EKMQ451VSN121MP35S	
	390	25.4×45	0.15	1.30	EKMQ351VSN391MQ45S	120	25.4×30	0.20	0.72	EKMQ451VSN121MQ30S	
	390	30×35	0.15	1.30	EKMQ351VSN391MR35S	150	22×40	0.20	0.79	EKMQ451VSN151MP40S	
	470	25.4×50	0.15	1.40	EKMQ351VSN471MQ50S	150	25.4×30	0.20	0.79	EKMQ451VSN151MQ30S	
	470	30×35	0.15	1.40	EKMQ351VSN471MR35S	150	30×25	0.20	0.79	EKMQ451VSN151MR25S	
	470	35×30	0.15	1.40	EKMQ351VSN471MA30S	180	22×45	0.20	0.87	EKMQ451VSN181MP45S	
	560	30×45	0.15	1.50	EKMQ351VSN561MR45S	180	25.4×40	0.20	0.87	EKMQ451VSN181MQ40S	
	560	35×35	0.15	1.50	EKMQ351VSN561MA35S	180	30×30	0.20	0.87	EKMQ451VSN181MR30S	
	680	30×50	0.15	1.70	EKMQ351VSN681MR50S	220	25.4×45	0.20	1.00	EKMQ451VSN221MQ45S	
680	35×40	0.15	1.70	EKMQ351VSN681MA40S	220	30×30	0.20	1.00	EKMQ451VSN221MR30S		
820	35×45	0.15	1.90	EKMQ351VSN821MA45S	220	35×25	0.20	1.00	EKMQ451VSN221MA25S		
400	100	22×25	0.15	0.70	EKMQ401VSN101MP25S	270	25.4×50	0.20	1.19	EKMQ451VSN271MQ50S	
	120	22×30	0.15	0.75	EKMQ401VSN121MP30S	270	30×40	0.20	1.19	EKMQ451VSN271MR40S	
	150	22×30	0.15	0.88	EKMQ401VSN151MP30S	270	35×30	0.20	1.19	EKMQ451VSN271MA30S	
	150	25.4×25	0.15	0.88	EKMQ401VSN151MQ25S	330	30×45	0.20	1.38	EKMQ451VSN331MR45S	
	180	22×35	0.15	0.95	EKMQ401VSN181MP35S	330	35×35	0.20	1.38	EKMQ451VSN331MA35S	
	180	25.4×30	0.15	0.95	EKMQ401VSN181MQ30S	390	30×50	0.20	1.55	EKMQ451VSN391MR50S	
	220	22×45	0.15	1.10	EKMQ401VSN221MP45S	390	35×40	0.20	1.55	EKMQ451VSN391MA40S	
	220	25.4×35	0.15	1.10	EKMQ401VSN221MQ35S	470	35×45	0.20	1.74	EKMQ451VSN471MA45S	
	220	30×25	0.15	1.10	EKMQ401VSN221MR25S	560	35×50	0.20	1.90	EKMQ451VSN561MA50S	
	270	22×50	0.15	1.22	EKMQ401VSN271MP50S						



## ◆RATED RIPPLE CURRENT MULTIPLIERS

### ●Frequency Multipliers

Frequency(Hz)	50	120	300	1k	10k	50k
35, 50V <sub>dc</sub>	0.95	1.00	1.03	1.05	1.08	1.08
160 to 250V <sub>dc</sub>	0.81	1.00	1.17	1.32	1.45	1.50
315 to 450V <sub>dc</sub>	0.77	1.00	1.16	1.30	1.41	1.43

The endurance of capacitors is reduced with internal heating produced by ripple current at the rate of halving the lifetime with every 5°C rise. When long life performance is required in actual use, the rms ripple current has to be reduced.

# SMM Series

- Downsize, longer life, and high ripple version of SMH series
- Endurance with ripple current : 3,000 hours at 85°C
- Non solvent resistant type
- RoHS Compliant

SMM

↑  
Downsized  
Longer life  
Higher ripple  
SMH



## ◆SPECIFICATIONS

Items	Characteristics		
Category Temperature Range	-25 to +85°C		
Rated Voltage Range	160 to 450V <sub>dc</sub>		
Capacitance Tolerance	±20% (M) (at 20°C, 120Hz)		
Leakage Current	$I \leq 3\sqrt{CV}$ (at 20°C after 5 minutes) Where, I : Max. leakage current (µA), C : Nominal capacitance (µF), V : Rated voltage (V)		
Dissipation Factor (tanδ)	Rated voltage (V <sub>dc</sub> )	160 to 400V	420 & 450V
	tanδ (Max.)	0.15	0.20
Low Temperature Characteristics (Max. Impedance Ratio)	Rated voltage (V <sub>dc</sub> )	160 to 400V	420 & 450V
	Z(-25°C)/Z(+20°C)	4	8
Endurance	The following specifications shall be satisfied when the capacitors are restored to 20°C after subjected to DC voltage with the rated ripple current is applied for 3,000 hours at 85°C.		
	Capacitance change	≤±20% of the initial value	
	D.F. (tanδ)	≤200% of the initial specified value	
	Leakage current	≤The initial specified value	
Shelf Life	The following specifications shall be satisfied when the capacitors are restored to 20°C after exposing them for 1,000 hours at 85°C without voltage applied.		
	Capacitance change	≤±15% of the initial value	
	D.F. (tanδ)	≤150% of the initial specified value	
	Leakage current	≤The initial specified value	

## ◆DIMENSIONS [mm]

- Terminal Code : VS (φ20 to φ35) : Standard

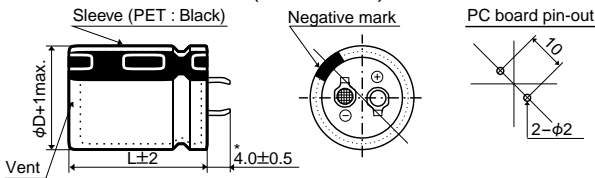

\*φD=35mm : 3.5±0.5mm

- Terminal Code : LI (φ35)

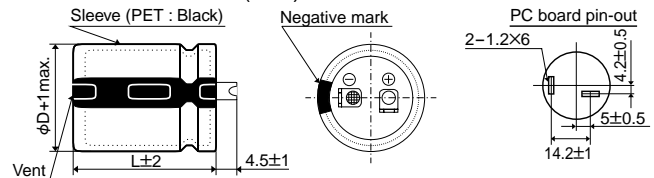

The standard design has no plastic disc.

## ◆PART NUMBERING SYSTEM

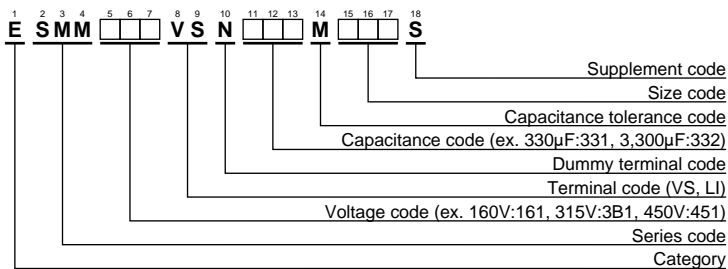

Please refer to "Product code guide (snap-in type)"

## ◆RATED RIPPLE CURRENT MULTIPLIERS

- Frequency Multipliers

Frequency(Hz)	50	120	300	1k	10k	50k
160 to 250V <sub>dc</sub>	0.81	1.00	1.17	1.32	1.45	1.50
315 to 450V <sub>dc</sub>	0.77	1.00	1.16	1.30	1.41	1.43

The endurance of capacitors is reduced with internal heating produced by ripple current at the rate of halving the lifetime with every 5°C rise. When long life performance is required in actual use, the rms ripple current has to be reduced.

◆STANDARD RATINGS

VV (Vdc)	Cap (μF)	Case size φD×L(mm)	tanδ	Rated ripple current (Arms/ 85°C,120Hz)	Part No.	VV (Vdc)	Cap (μF)	Case size φD×L(mm)	tanδ	Rated ripple current (Arms/ 85°C,120Hz)	Part No.	
160	270	20×25	0.15	1.28	ESMM161VSN271MN25S	180	1,200	25.4×45	0.15	3.63	ESMM181VSN122MQ45S	
	270	22×20	0.15	1.30	ESMM161VSN271MP20S		1,200	30×35	0.15	3.55	ESMM181VSN122MR35S	
	330	20×25	0.15	1.55	ESMM161VSN331MN25S		1,200	35×30	0.15	3.49	ESMM181VSN122MA30S	
	390	20×30	0.15	1.63	ESMM161VSN391MN30S		1,500	30×40	0.15	4.10	ESMM181VSN152MR40S	
	390	22×25	0.15	1.63	ESMM161VSN391MP25S		1,500	35×35	0.15	4.02	ESMM181VSN152MA35S	
	390	25.4×20	0.15	1.62	ESMM161VSN391MQ20S		1,800	30×45	0.15	4.55	ESMM181VSN182MR45S	
	470	20×30	0.15	1.90	ESMM161VSN471MN30S		1,800	35×35	0.15	4.54	ESMM181VSN182MA35S	
	470	22×30	0.15	1.86	ESMM161VSN471MP30S		2,200	35×40	0.15	4.83	ESMM181VSN222MA40S	
	470	25.4×25	0.15	1.86	ESMM161VSN471MQ25S		2,700	35×50	0.15	5.30	ESMM181VSN272MA50S	
	560	20×35	0.15	2.14	ESMM161VSN561MN35S		200	220	20×25	0.15	1.19	ESMM201VSN221MN25S
	560	22×30	0.15	2.15	ESMM161VSN561MP30S			220	22×20	0.15	1.18	ESMM201VSN221MP20S
	560	25.4×25	0.15	2.15	ESMM161VSN561MQ25S			270	20×25	0.15	1.39	ESMM201VSN271MN25S
	560	30×20	0.15	2.05	ESMM161VSN561MP20S			270	22×25	0.15	1.37	ESMM201VSN271MP25S
	680	20×40	0.15	2.35	ESMM161VSN681MN40S			270	25.4×20	0.15	1.35	ESMM201VSN271MQ20S
	680	22×35	0.15	2.35	ESMM161VSN681MP35S			330	20×30	0.15	1.56	ESMM201VSN331MN30S
	680	25.4×30	0.15	2.33	ESMM161VSN681MQ30S			330	22×25	0.15	1.51	ESMM201VSN331MP25S
	680	30×25	0.15	2.33	ESMM161VSN681MR25S			330	25.4×20	0.15	1.49	ESMM201VSN331MQ20S
	680	35×20	0.15	2.26	ESMM161VSN681MA20S			390	20×35	0.15	1.74	ESMM201VSN391MN35S
	820	20×45	0.15	2.64	ESMM161VSN821MN45S	390		22×30	0.15	1.73	ESMM201VSN391MP30S	
	820	22×40	0.15	2.68	ESMM161VSN821MP40S	390		25.4×25	0.15	1.71	ESMM201VSN391MQ25S	
	820	25.4×30	0.15	2.65	ESMM161VSN821MQ30S	390		30×20	0.15	1.71	ESMM201VSN391MR20S	
	820	30×25	0.15	2.64	ESMM161VSN821MR25S	470		20×35	0.15	2.03	ESMM201VSN471MN35S	
	820	35×20	0.15	2.49	ESMM161VSN821MA20S	470		22×30	0.15	1.97	ESMM201VSN471MP30S	
	1,000	22×45	0.15	3.02	ESMM161VSN102MP45S	470		25.4×25	0.15	1.95	ESMM201VSN471MQ25S	
	1,000	25.4×35	0.15	3.00	ESMM161VSN102MQ35S	470		30×20	0.15	1.88	ESMM201VSN471MR20S	
	1,000	30×30	0.15	2.96	ESMM161VSN102MR30S	560		20×40	0.15	2.18	ESMM201VSN561MN40S	
	1,000	35×25	0.15	3.13	ESMM161VSN102MA25S	560		22×35	0.15	2.18	ESMM201VSN561MP35S	
	1,200	22×50	0.15	3.47	ESMM161VSN122MP50S	560	25.4×30	0.15	2.15	ESMM201VSN561MQ30S		
	1,200	25.4×40	0.15	3.43	ESMM161VSN122MQ40S	560	30×25	0.15	2.15	ESMM201VSN561MR25S		
	1,200	30×30	0.15	3.41	ESMM161VSN122MR30S	560	35×20	0.15	2.05	ESMM201VSN561MA20S		
	1,200	35×25	0.15	3.40	ESMM161VSN122MA25S	680	20×50	0.15	2.48	ESMM201VSN681MN50S		
	1,500	25.4×50	0.15	3.96	ESMM161VSN152MQ50S	680	22×40	0.15	2.48	ESMM201VSN681MP40S		
	1,500	30×35	0.15	3.96	ESMM161VSN152MR35S	680	25.4×30	0.15	2.48	ESMM201VSN681MQ30S		
	1,500	35×30	0.15	3.94	ESMM161VSN152MA30S	680	30×25	0.15	2.48	ESMM201VSN681MR25S		
	1,800	30×40	0.15	4.31	ESMM161VSN182MR40S	680	35×20	0.15	2.36	ESMM201VSN681MA20S		
	1,800	35×35	0.15	4.28	ESMM161VSN182MA35S	820	22×45	0.15	2.81	ESMM201VSN821MP45S		
2,200	30×50	0.15	4.96	ESMM161VSN222MR50S	820	25.4×35	0.15	2.79	ESMM201VSN821MQ35S			
2,200	35×40	0.15	4.96	ESMM161VSN222MA40S	820	30×30	0.15	2.80	ESMM201VSN821MR30S			
2,700	35×45	0.15	5.57	ESMM161VSN272MA45S	820	35×25	0.15	2.83	ESMM201VSN821MA25S			
3,300	35×50	0.15	6.21	ESMM161VSN332MA50S	1,000	22×50	0.15	3.28	ESMM201VSN102MP50S			
180	220	22×20	0.15	1.18	ESMM181VSN221MP20S	1,000	25.4×40	0.15	3.28	ESMM201VSN102MQ40S		
	270	20×25	0.15	1.29	ESMM181VSN271MN25S	1,000	30×35	0.15	3.15	ESMM201VSN102MR35S		
	330	20×30	0.15	1.77	ESMM181VSN331MN30S	1,000	35×30	0.15	3.26	ESMM201VSN102MA30S		
	330	22×25	0.15	1.77	ESMM181VSN331MP25S	1,200	25.4×45	0.15	3.61	ESMM201VSN122MQ45S		
	330	25.4×20	0.15	1.49	ESMM181VSN331MQ20S	1,200	30×35	0.15	3.61	ESMM201VSN122MR35S		
	390	20×30	0.15	1.84	ESMM181VSN391MN30S	1,200	35×30	0.15	3.57	ESMM201VSN122MA30S		
	390	22×25	0.15	1.84	ESMM181VSN391MP25S	1,500	30×45	0.15	4.13	ESMM201VSN152MR45S		
	470	20×35	0.15	1.91	ESMM181VSN471MN35S	1,500	35×35	0.15	4.06	ESMM201VSN152MA35S		
	470	22×30	0.15	1.91	ESMM181VSN471MP30S	1,800	30×50	0.15	4.60	ESMM201VSN182MR50S		
	470	25.4×25	0.15	2.08	ESMM181VSN471MQ25S	1,800	35×40	0.15	4.59	ESMM201VSN182MA40S		
	470	30×20	0.15	1.88	ESMM181VSN471MR20S	2,200	35×45	0.15	5.25	ESMM201VSN222MA45S		
	560	20×40	0.15	2.15	ESMM181VSN561MN40S	220	180	22×20	0.15	1.06	ESMM221VSN181MP20S	
	560	22×35	0.15	2.25	ESMM181VSN561MP35S		220	20×25	0.15	1.25	ESMM221VSN221MN25S	
	560	25.4×25	0.15	2.25	ESMM181VSN561MQ25S		270	20×30	0.15	1.46	ESMM221VSN271MN30S	
	680	20×45	0.15	2.41	ESMM181VSN681MN45S		270	22×25	0.15	1.47	ESMM221VSN271MP25S	
	680	22×35	0.15	2.48	ESMM181VSN681MP35S		270	25.4×20	0.15	1.35	ESMM221VSN271MQ20S	
	680	25.4×30	0.15	2.50	ESMM181VSN681MQ30S		330	20×35	0.15	1.64	ESMM221VSN331MN35S	
	680	30×25	0.15	2.46	ESMM181VSN681MR25S		330	22×30	0.15	1.70	ESMM221VSN331MP30S	
	680	35×20	0.15	2.26	ESMM181VSN681MA20S		330	25.4×25	0.15	1.69	ESMM221VSN331MQ25S	
	820	20×50	0.15	2.72	ESMM181VSN821MN50S		330	30×20	0.15	1.58	ESMM221VSN331MR20S	
	820	22×40	0.15	2.86	ESMM181VSN821MP40S		390	20×35	0.15	1.84	ESMM221VSN391MN35S	
	820	25.4×35	0.15	2.75	ESMM181VSN821MQ35S		390	22×30	0.15	1.89	ESMM221VSN391MP30S	
	820	30×25	0.15	2.69	ESMM181VSN821MR25S		390	25.4×25	0.15	1.84	ESMM221VSN391MQ25S	
	1,000	22×50	0.15	3.10	ESMM181VSN102MP50S		390	30×20	0.15	1.71	ESMM221VSN391MR20S	
	1,000	25.4×40	0.15	3.06	ESMM181VSN102MQ40S		470	20×40	0.15	2.12	ESMM221VSN471MN40S	
	1,000	30×30	0.15	3.10	ESMM181VSN102MR30S		470	22×35	0.15	2.08	ESMM221VSN471MP35S	
	1,000	35×25	0.15	2.98	ESMM181VSN102MA25S		470	25.4×30	0.15	2.08	ESMM221VSN471MQ30S	

◆STANDARD RATINGS

WV (Vdc)	Cap (μF)	Case size φD×L(mm)	tanδ	Rated ripple current (Arms/85°C,120Hz)	Part No.	WV (Vdc)	Cap (μF)	Case size φD×L(mm)	tanδ	Rated ripple current (Arms/85°C,120Hz)	Part No.
220	470	30×25	0.15	2.12	ESMM221VSN471MR25S	315	180	22×30	0.15	1.29	ESMM3B1VSN181MP30S
	470	35×20	0.15	1.88	ESMM221VSN471MA20S		180	25.4×25	0.15	1.38	ESMM3B1VSN181MQ25S
	560	20×50	0.15	2.33	ESMM221VSN561MN50S		180	30×20	0.15	1.16	ESMM3B1VSN181MR20S
	560	22×40	0.15	2.33	ESMM221VSN561MP40S		220	20×35	0.15	1.30	ESMM3B1VSN221MN35S
	560	25.4×35	0.15	2.38	ESMM221VSN561MQ35S		220	22×30	0.15	1.41	ESMM3B1VSN221MP30S
	560	30×25	0.15	2.31	ESMM221VSN561MR25S		220	25.4×25	0.15	1.47	ESMM3B1VSN221MQ25S
	560	35×20	0.15	2.14	ESMM221VSN561MA20S		220	30×20	0.15	1.28	ESMM3B1VSN221MR20S
	680	22×45	0.15	2.63	ESMM221VSN681MP45S		270	20×45	0.15	1.52	ESMM3B1VSN271MN45S
	680	25.4×35	0.15	2.68	ESMM221VSN681MQ35S		270	22×35	0.15	1.68	ESMM3B1VSN271MP35S
	680	30×30	0.15	2.62	ESMM221VSN681MR30S		270	25.4×30	0.15	1.70	ESMM3B1VSN271MQ30S
	680	35×25	0.15	2.58	ESMM221VSN681MA25S		270	30×25	0.15	1.55	ESMM3B1VSN271MR25S
	820	25.4×45	0.15	3.01	ESMM221VSN821MQ45S		270	35×20	0.15	1.43	ESMM3B1VSN271MA20S
	820	30×35	0.15	2.99	ESMM221VSN821MR35S		330	20×50	0.15	1.73	ESMM3B1VSN331MP30S
	820	35×30	0.15	2.79	ESMM221VSN821MA30S		330	22×40	0.15	1.91	ESMM3B1VSN331MP40S
	1,000	25.4×50	0.15	3.40	ESMM221VSN102MQ50S		330	25.4×35	0.15	1.94	ESMM3B1VSN331MQ35S
	1,000	30×35	0.15	3.42	ESMM221VSN102MR35S		330	30×25	0.15	1.98	ESMM3B1VSN331MR25S
	1,000	35×30	0.15	3.29	ESMM221VSN102MA30S		390	22×45	0.15	2.07	ESMM3B1VSN391MP45S
	1,200	30×40	0.15	3.88	ESMM221VSN122MR40S		390	25.4×40	0.15	2.11	ESMM3B1VSN391MQ40S
	1,200	35×35	0.15	3.68	ESMM221VSN122MA35S		390	30×30	0.15	2.15	ESMM3B1VSN391MR30S
	1,500	30×50	0.15	4.44	ESMM221VSN152MR50S		390	35×25	0.15	1.95	ESMM3B1VSN391MA25S
1,500	35×40	0.15	4.10	ESMM221VSN152MA40S	470	25.4×45	0.15	2.31	ESMM3B1VSN471MQ45S		
1,800	35×45	0.15	4.52	ESMM221VSN182MA45S	470	30×35	0.15	2.38	ESMM3B1VSN471MR35S		
250	150	22×20	0.15	0.97	ESMM251VSN151MP20S	470	35×30	0.15	2.46	ESMM3B1VSN471MA30S	
	180	20×25	0.15	1.20	ESMM251VSN181MN25S	560	25.4×50	0.15	2.46	ESMM3B1VSN561MQ50S	
	180	22×20	0.15	1.06	ESMM251VSN181MP20S	560	30×35	0.15	2.63	ESMM3B1VSN561MR35S	
	220	20×25	0.15	1.26	ESMM251VSN221MN25S	560	35×30	0.15	2.69	ESMM3B1VSN561MA30S	
	220	22×25	0.15	1.24	ESMM251VSN221MP25S	680	30×45	0.15	2.82	ESMM3B1VSN681MR45S	
	220	25.4×20	0.15	1.22	ESMM251VSN221MQ20S	680	35×35	0.15	3.05	ESMM3B1VSN681MA35S	
	270	20×30	0.15	1.42	ESMM251VSN271MN30S	820	30×50	0.15	3.28	ESMM3B1VSN821MR50S	
	270	22×25	0.15	1.50	ESMM251VSN271MP25S	820	35×40	0.15	3.45	ESMM3B1VSN821MA40S	
	330	20×35	0.15	1.68	ESMM251VSN331MN35S	1,000	35×45	0.15	3.59	ESMM3B1VSN102MA45S	
	330	22×30	0.15	1.66	ESMM251VSN331MP30S	350	82	22×20	0.15	0.72	ESMM351VSN820MP20S
	330	25.4×25	0.15	1.61	ESMM251VSN331MQ25S		100	20×25	0.15	0.81	ESMM351VSN101MN25S
	330	30×20	0.15	1.58	ESMM251VSN331MR20S		120	20×30	0.15	0.96	ESMM351VSN121MN30S
	390	20×40	0.15	1.92	ESMM251VSN391MN40S		120	22×25	0.15	1.04	ESMM351VSN121MP25S
	390	22×35	0.15	1.88	ESMM251VSN391MP35S		120	25.4×20	0.15	0.90	ESMM351VSN121MQ20S
	390	25.4×30	0.15	1.88	ESMM251VSN391MQ30S		150	20×30	0.15	1.10	ESMM351VSN151MN30S
	390	30×25	0.15	1.86	ESMM251VSN391MR25S		150	22×30	0.15	1.20	ESMM351VSN151MP30S
	390	35×20	0.15	1.71	ESMM251VSN391MA20S		150	25.4×25	0.15	1.22	ESMM351VSN151MQ25S
	470	20×50	0.15	2.06	ESMM251VSN471MN50S		150	30×20	0.15	1.06	ESMM351VSN151MR20S
	470	22×35	0.15	2.15	ESMM251VSN471MP35S		180	20×35	0.15	1.24	ESMM351VSN181MN35S
	470	25.4×35	0.15	2.15	ESMM251VSN471MQ35S		180	22×30	0.15	1.34	ESMM351VSN181MP30S
	470	30×25	0.15	2.05	ESMM251VSN471MR25S		180	25.4×25	0.15	1.37	ESMM351VSN181MQ25S
	470	35×20	0.15	1.88	ESMM251VSN471MA20S		180	30×20	0.15	1.16	ESMM351VSN181MR20S
	560	22×40	0.15	2.48	ESMM251VSN561MP40S		220	20×45	0.15	1.37	ESMM351VSN221MN45S
	560	25.4×35	0.15	2.35	ESMM251VSN561MQ35S		220	22×35	0.15	1.47	ESMM351VSN221MP35S
	560	30×25	0.15	2.35	ESMM251VSN561MR25S		220	25.4×30	0.15	1.53	ESMM351VSN221MQ30S
	680	22×50	0.15	2.61	ESMM251VSN681MP50S		220	30×25	0.15	1.54	ESMM351VSN221MR25S
	680	25.4×40	0.15	2.67	ESMM251VSN681MQ40S		220	35×20	0.15	1.29	ESMM351VSN221MA20S
	680	30×30	0.15	2.71	ESMM251VSN681MR30S		270	20×50	0.15	1.56	ESMM351VSN271MN50S
	680	35×25	0.15	2.58	ESMM251VSN681MA25S		270	22×40	0.15	1.70	ESMM351VSN271MP40S
	820	25.4×45	0.15	3.01	ESMM251VSN821MQ45S		270	25.4×35	0.15	1.73	ESMM351VSN271MQ35S
820	30×35	0.15	2.98	ESMM251VSN821MR35S	270		30×25	0.15	1.80	ESMM351VSN271MA25S	
820	35×30	0.15	2.96	ESMM251VSN821MA30S	270		35×20	0.15	1.49	ESMM351VSN271MA20S	
1,000	30×40	0.15	3.56	ESMM251VSN102MR40S	330		22×45	0.15	1.87	ESMM351VSN331MP45S	
1,000	35×35	0.15	3.48	ESMM251VSN102MA35S	330		25.4×35	0.15	1.97	ESMM351VSN331MQ35S	
1,200	30×45	0.15	3.99	ESMM251VSN122MR45S	330		30×30	0.15	2.03	ESMM351VSN331MR30S	
1,200	35×35	0.15	3.84	ESMM251VSN122MA35S	330		35×25	0.15	1.80	ESMM351VSN331MA25S	
1,500	35×40	0.15	4.33	ESMM251VSN152MA40S	390		25.4×40	0.15	2.14	ESMM351VSN391MQ40S	
1,800	35×50	0.15	4.54	ESMM251VSN182MA50S	390		30×35	0.15	2.23	ESMM351VSN391MR35S	
315	100	22×20	0.15	0.79	ESMM3B1VSN101MP20S		390	35×30	0.15	2.30	ESMM351VSN391MA30S
	120	20×25	0.15	0.89	ESMM3B1VSN121MN25S	470	25.4×50	0.15	2.55	ESMM351VSN471MQ50S	
	120	25.4×20	0.15	0.90	ESMM3B1VSN121MQ20S	470	30×35	0.15	2.53	ESMM351VSN471MR35S	
	150	20×30	0.15	1.05	ESMM3B1VSN151MN30S	470	35×30	0.15	2.55	ESMM351VSN471MA30S	
	150	22×25	0.15	1.06	ESMM3B1VSN151MP25S	560	30×40	0.15	2.73	ESMM351VSN561MR40S	
	150	25.4×20	0.15	1.00	ESMM3B1VSN151MQ20S	560	35×35	0.15	2.75	ESMM351VSN561MA35S	
	180	20×35	0.15	1.18	ESMM3B1VSN181MN35S	680	30×50	0.15	3.15	ESMM351VSN681MR50S	

◆STANDARD RATINGS

WV (Vdc)	Cap (μF)	Case size φDXL(mm)	tanδ	Rated ripple current (Arms/85°C,120Hz)	Part No.	WV (Vdc)	Cap (μF)	Case size φDXL(mm)	tanδ	Rated ripple current (Arms/85°C,120Hz)	Part No.	
350	680	35×40	0.15	3.15	ESMM351VSN681MA40S	420	180	20×50	0.20	1.27	ESMM421VSN181MN50S	
	820	35×45	0.15	3.47	ESMM351VSN821MA45S		180	22×40	0.20	1.33	ESMM421VSN181MP40S	
	1,000	35×50	0.15	3.60	ESMM351VSN102MA50S		180	25.4×35	0.20	1.42	ESMM421VSN181MQ35S	
400	68	20×25	0.15	0.75	ESMM401VSN680MN25S		180	30×25	0.20	1.48	ESMM421VSN181MR25S	
	68	22×20	0.15	0.65	ESMM401VSN680MP20S		180	35×20	0.20	1.16	ESMM421VSN181MA20S	
	82	20×25	0.15	0.82	ESMM401VSN820MN25S		220	22×45	0.20	1.55	ESMM421VSN221MP45S	
	82	22×25	0.15	0.84	ESMM401VSN820MP25S		220	25.4×35	0.20	1.58	ESMM421VSN221MQ35S	
	82	25.4×20	0.15	0.74	ESMM401VSN820MQ20S		220	30×30	0.20	1.65	ESMM421VSN221MR30S	
	100	20×30	0.15	0.95	ESMM401VSN101MP30S		220	35×25	0.20	1.47	ESMM421VSN221MA25S	
	100	22×25	0.15	0.99	ESMM401VSN101MP25S		270	25.4×40	0.20	1.74	ESMM421VSN271MQ40S	
	100	25.4×20	0.15	0.82	ESMM401VSN101MQ20S		270	30×35	0.20	1.90	ESMM421VSN271MR35S	
	120	20×35	0.15	1.07	ESMM401VSN121MN35S		270	35×30	0.20	1.94	ESMM421VSN271MA30S	
	120	22×30	0.15	1.09	ESMM401VSN121MP30S		330	25.4×50	0.20	2.20	ESMM421VSN331MQ50S	
	120	25.4×25	0.15	1.13	ESMM401VSN121MQ25S		330	30×35	0.20	1.98	ESMM421VSN331MR35S	
	120	30×20	0.15	0.95	ESMM401VSN121MR20S		330	35×35	0.20	2.17	ESMM421VSN331MA35S	
	150	20×40	0.15	1.22	ESMM401VSN151MN40S		390	30×40	0.20	2.22	ESMM421VSN391MR40S	
	150	22×35	0.15	1.24	ESMM401VSN151MP35S		390	35×35	0.20	2.27	ESMM421VSN391MA35S	
	150	25.4×30	0.15	1.27	ESMM401VSN151MQ30S		470	30×45	0.20	2.50	ESMM421VSN471MR45S	
	150	30×25	0.15	1.20	ESMM401VSN151MR25S		470	35×40	0.20	2.61	ESMM421VSN471MA40S	
	180	20×45	0.15	1.28	ESMM401VSN181MN45S		560	35×45	0.20	2.95	ESMM421VSN561MA45S	
	180	22×40	0.15	1.41	ESMM401VSN181MP40S		680	35×50	0.20	3.15	ESMM421VSN681MA50S	
	180	25.4×30	0.15	1.44	ESMM401VSN181MQ30S		450	47	22×20	0.20	0.54	ESMM451VSN470MP20S
	180	30×25	0.15	1.52	ESMM401VSN181MR25S			56	20×25	0.20	0.61	ESMM451VSN560MN25S
	180	35×20	0.15	1.16	ESMM401VSN181MA20S			56	22×20	0.20	0.59	ESMM451VSN560MP20S
	220	20×50	0.15	1.41	ESMM401VSN221MN50S			68	20×30	0.20	0.71	ESMM451VSN680MN30S
	220	22×45	0.15	1.58	ESMM401VSN221MP45S			68	22×25	0.20	0.71	ESMM451VSN680MP25S
	220	25.4×35	0.15	1.64	ESMM401VSN221MQ35S			68	25.4×20	0.20	0.68	ESMM451VSN680MQ20S
	220	30×30	0.15	1.66	ESMM401VSN221MR30S			82	20×35	0.20	0.80	ESMM451VSN820MN35S
	220	35×25	0.15	1.47	ESMM401VSN221MA25S			82	22×25	0.20	0.86	ESMM451VSN820MP25S
	270	22×50	0.15	1.65	ESMM401VSN271MP50S			82	25.4×20	0.20	0.74	ESMM451VSN820MQ20S
	270	25.4×40	0.15	1.79	ESMM401VSN271MQ40S	82		30×20	0.20	0.79	ESMM451VSN820MR20S	
	270	30×30	0.15	1.82	ESMM401VSN271MR30S	100		20×35	0.20	0.88	ESMM451VSN101MN35S	
	270	35×25	0.15	1.63	ESMM401VSN271MA25S	100		22×30	0.20	0.95	ESMM451VSN101MP30S	
	330	25.4×45	0.15	2.00	ESMM401VSN331MQ45S	100		25.4×25	0.20	0.97	ESMM451VSN101MQ25S	
	330	30×35	0.15	2.05	ESMM401VSN331MR35S	100		30×20	0.20	0.87	ESMM451VSN101MR20S	
	330	35×30	0.15	2.05	ESMM401VSN331MA30S	120		20×40	0.20	0.99	ESMM451VSN121MN40S	
	390	25.4×50	0.15	2.12	ESMM401VSN391MQ50S	120		22×35	0.20	1.07	ESMM451VSN121MP35S	
	390	30×40	0.15	2.26	ESMM401VSN391MR40S	120		25.4×30	0.20	1.09	ESMM451VSN121MQ30S	
	390	35×35	0.15	2.28	ESMM401VSN391MA35S	120		30×25	0.20	1.12	ESMM451VSN121MR25S	
470	30×45	0.15	2.51	ESMM401VSN471MR45S	120	35×20		0.20	0.99	ESMM451VSN121MA20S		
470	35×35	0.15	2.54	ESMM401VSN471MA35S	150	20×45		0.20	1.13	ESMM451VSN151MN45S		
560	30×50	0.15	2.85	ESMM401VSN561MR50S	150	22×40		0.20	1.18	ESMM451VSN151MP40S		
560	35×40	0.15	2.85	ESMM401VSN561MA40S	150	25.4×30		0.20	1.25	ESMM451VSN151MQ30S		
680	35×50	0.15	3.10	ESMM401VSN681MA50S	150	30×25		0.20	1.29	ESMM451VSN151MR25S		
420	47	22×20	0.20	0.54	ESMM421VSN470MP20S	150		35×20	0.20	1.06	ESMM451VSN151MA20S	
	56	20×25	0.20	0.58	ESMM421VSN560MN25S	180		22×45	0.20	1.32	ESMM451VSN181MP45S	
	56	22×20	0.20	0.59	ESMM421VSN560MP20S	180		25.4×35	0.20	1.40	ESMM451VSN181MQ35S	
	68	20×25	0.20	0.70	ESMM421VSN680MN25S	180		30×30	0.20	1.45	ESMM451VSN181MR30S	
	68	25.4×20	0.20	0.68	ESMM421VSN680MQ20S	180		35×25	0.20	1.33	ESMM451VSN181MA25S	
	82	20×30	0.20	0.80	ESMM421VSN820MN30S	220		22×50	0.20	1.48	ESMM451VSN221MP50S	
	82	22×25	0.20	0.85	ESMM421VSN820MP25S	220		25.4×40	0.20	1.59	ESMM451VSN221MQ40S	
	82	25.4×20	0.20	0.74	ESMM421VSN820MQ20S	220	30×30	0.20	1.64	ESMM451VSN221MR30S		
	100	20×35	0.20	0.90	ESMM421VSN101MN35S	220	35×25	0.20	1.66	ESMM451VSN221MA25S		
	100	22×30	0.20	0.97	ESMM421VSN101MP30S	270	25.4×45	0.20	1.73	ESMM451VSN271MQ45S		
	100	25.4×25	0.20	0.98	ESMM421VSN101MQ25S	270	30×35	0.20	1.89	ESMM451VSN271MR35S		
	100	30×20	0.20	0.87	ESMM421VSN101MR20S	270	35×30	0.20	1.90	ESMM451VSN271MA30S		
	120	20×35	0.20	1.04	ESMM421VSN121MN35S	330	25.4×50	0.20	2.12	ESMM451VSN331MQ50S		
	120	22×30	0.20	1.07	ESMM421VSN121MP30S	330	30×40	0.20	2.12	ESMM451VSN331MR40S		
	120	25.4×25	0.20	1.08	ESMM421VSN121MQ25S	330	35×35	0.20	2.15	ESMM451VSN331MA35S		
	120	30×20	0.20	0.95	ESMM421VSN121MR20S	390	30×45	0.20	2.35	ESMM451VSN391MR45S		
	150	20×40	0.20	1.17	ESMM421VSN151MN40S	390	35×40	0.20	2.38	ESMM451VSN391MA40S		
	150	22×35	0.20	1.21	ESMM421VSN151MP35S	470	30×50	0.20	2.65	ESMM451VSN471MR50S		
	150	25.4×30	0.20	1.26	ESMM421VSN151MQ30S	470	35×45	0.20	2.68	ESMM451VSN471MA45S		
	150	30×25	0.20	1.30	ESMM421VSN151MR25S	560	35×50	0.20	2.88	ESMM451VSN561MA50S		
	150	35×20	0.20	1.11	ESMM421VSN151MA20S							

New!

# KMS Series

- Longer life than current snap-ins KMQ series
- Downsized from current downsized snap-ins KMM series
- Endurance with ripple current : 105°C 3,000 hours
- Rated voltage range : 160 to 450V
- Capacitance range : 82 to 3,300μF
- Non solvent resistant type
- RoHS Compliant

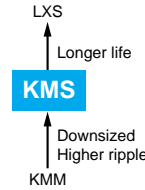

## ◆ SPECIFICATIONS

Items	Characteristics		
Category Temperature Range	-25 to +105°C		
Rated Voltage Range	160 to 450V <sub>dc</sub>		
Capacitance Tolerance	±20% (M) (at 20°C, 120Hz)		
Leakage Current	I ≤ 3√CV Where, I : Max. leakage current (μA), C : Nominal capacitance (μF), V : Rated voltage (V) (at 20°C after 5 minutes)		
Dissipation Factor (tanδ)	Rated voltage (V <sub>dc</sub> )	160 to 400V	420 & 450V
	tanδ (Max.)	0.15	0.20
Low Temperature Characteristics (Max. Impedance Ratio)	Rated voltage (V <sub>dc</sub> )	160 to 400V	420 & 450V
	Z(-25°C)/Z(+20°C)	4	8
Endurance	The following specifications shall be satisfied when the capacitors are restored to 20°C after subjected to DC voltage with the rated ripple current is applied for 3,000 hours at 105°C.		
	Capacitance change	≤ ±20% of the initial value	
	D.F. (tanδ)	≤ 200% of the initial specified value	
	Leakage current	≤ The initial specified value	
Shelf Life	The following specifications shall be satisfied when the capacitors are restored to 20°C after exposing them for 1,000 hours at 105°C without voltage applied.		
	Capacitance change	≤ ±15% of the initial value	
	D.F. (tanδ)	≤ 150% of the initial specified value	
	Leakage current	≤ The initial specified value	

## ◆ DIMENSIONS [mm]

● Terminal Code : VS (φ22 to φ35) : Standard

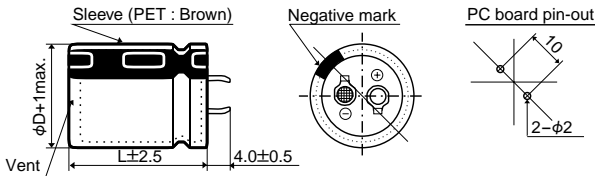

● Terminal Code : LI (φ35)

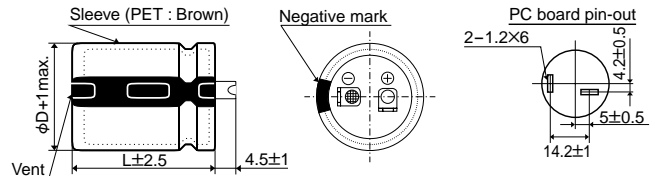

The standard design has no plastic disc.

## ◆ PART NUMBERING SYSTEM

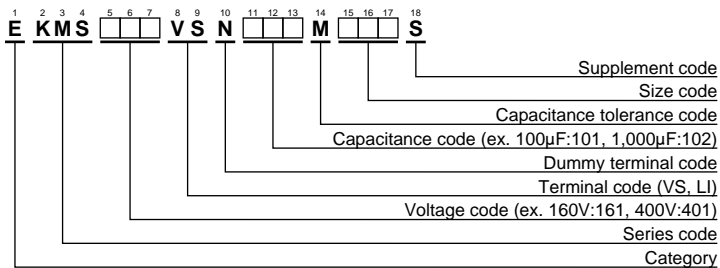

Please refer to "Product code guide (snap-in type)"



New!

KMS Series

◆STANDARD RATINGS

WV (Vdc)	Cap (μF)	Case size φD×L(mm)	tanδ	Rated ripple current (Arms/105°C,120Hz)	Part No.	WV (Vdc)	Cap (μF)	Case size φD×L(mm)	tanδ	Rated ripple current (Arms/105°C,120Hz)	Part No.
160	470	22 × 25	0.15	1.47	EKMS161VSN471MP25S	200	1,800	30 × 45	0.15	3.66	EKMS201VSN182MR45S
	680	22 × 30	0.15	1.86	EKMS161VSN681MP30S		1,800	30 × 50	0.15	3.72	EKMS201VSN182MR50S
	680	25.4 × 25	0.15	1.84	EKMS161VSN681MQ25S		1,800	35 × 40	0.15	3.81	EKMS201VSN182MA40S
	820	22 × 35	0.15	2.09	EKMS161VSN821MP35S		2,200	35 × 45	0.15	4.32	EKMS201VSN222MA45S
	820	25.4 × 30	0.15	2.08	EKMS161VSN821MQ30S		2,700	35 × 50	0.15	4.88	EKMS201VSN272MA50S
	1,000	22 × 40	0.15	2.35	EKMS161VSN102MP40S		270	22 × 25	0.15	1.11	EKMS251VSN271MP25S
	1,000	22 × 45	0.15	2.40	EKMS161VSN102MP45S		330	22 × 30	0.15	1.29	EKMS251VSN331MP30S
	1,000	25.4 × 35	0.15	2.40	EKMS161VSN102MQ35S		390	22 × 35	0.15	1.44	EKMS251VSN391MP35S
	1,000	30 × 25	0.15	2.50	EKMS161VSN102MR25S		390	25.4 × 25	0.15	1.40	EKMS251VSN391MQ25S
	1,200	22 × 50	0.15	2.69	EKMS161VSN122MP50S		470	22 × 40	0.15	1.61	EKMS251VSN471MP40S
	1,200	25.4 × 40	0.15	2.68	EKMS161VSN122MQ40S		470	25.4 × 30	0.15	1.57	EKMS251VSN471MQ30S
	1,200	30 × 30	0.15	2.77	EKMS161VSN122MR30S		560	22 × 45	0.15	1.79	EKMS251VSN561MP45S
	1,200	35 × 25	0.15	2.91	EKMS161VSN122MA25S		560	25.4 × 35	0.15	1.79	EKMS251VSN561MQ35S
	1,500	25.4 × 45	0.15	3.05	EKMS161VSN152MQ45S		560	30 × 25	0.15	1.87	EKMS251VSN561MR25S
	1,500	30 × 35	0.15	3.17	EKMS161VSN152MR35S		680	22 × 50	0.15	2.02	EKMS251VSN681MP50S
	1,800	25.4 × 50	0.15	3.40	EKMS161VSN182MQ50S		680	25.4 × 40	0.15	2.02	EKMS251VSN681MQ40S
	1,800	30 × 40	0.15	3.57	EKMS161VSN182MR40S		680	30 × 30	0.15	2.08	EKMS251VSN681MR30S
	1,800	35 × 30	0.15	3.62	EKMS161VSN182MA30S		680	35 × 25	0.15	2.19	EKMS251VSN681MA25S
	2,200	30 × 45	0.15	4.05	EKMS161VSN222MR45S		820	25.4 × 45	0.15	2.26	EKMS251VSN821MQ45S
	2,200	35 × 35	0.15	4.07	EKMS161VSN222MA35S		820	30 × 35	0.15	2.34	EKMS251VSN821MR35S
2,700	30 × 50	0.15	4.56	EKMS161VSN272MR50S	1,000	25.4 × 50	0.15	2.53	EKMS251VSN102MQ50S		
2,700	35 × 40	0.15	4.67	EKMS161VSN272MA40S	1,000	30 × 40	0.15	2.66	EKMS251VSN102MR40S		
2,700	35 × 45	0.15	4.78	EKMS161VSN272MA45S	1,000	35 × 30	0.15	2.70	EKMS251VSN102MA30S		
3,300	35 × 50	0.15	5.40	EKMS161VSN332MA50S	1,200	30 × 45	0.15	2.99	EKMS251VSN122MR45S		
180	390	22 × 25	0.15	1.34	EKMS181VSN391MP25S	1,200	30 × 50	0.15	3.04	EKMS251VSN122MR50S	
	560	22 × 30	0.15	1.68	EKMS181VSN561MP30S	1,200	35 × 35	0.15	3.00	EKMS251VSN122MA35S	
	560	25.4 × 25	0.15	1.67	EKMS181VSN561MQ25S	1,500	35 × 40	0.15	3.48	EKMS251VSN152MA40S	
	680	22 × 35	0.15	1.90	EKMS181VSN681MP35S	1,500	35 × 45	0.15	3.56	EKMS251VSN152MA45S	
	820	22 × 40	0.15	2.13	EKMS181VSN821MP40S	1,800	35 × 50	0.15	3.98	EKMS251VSN182MA50S	
	820	25.4 × 30	0.15	2.08	EKMS181VSN821MQ30S	180	22 × 25	0.15	0.95	EKMS3B1VSN181MP25S	
	820	30 × 25	0.15	2.26	EKMS181VSN821MR25S	220	22 × 30	0.15	1.10	EKMS3B1VSN221MP30S	
	1,000	22 × 45	0.15	2.40	EKMS181VSN102MP45S	220	25.4 × 25	0.15	1.10	EKMS3B1VSN221MQ25S	
	1,000	22 × 50	0.15	2.45	EKMS181VSN102MP50S	270	22 × 35	0.15	1.24	EKMS3B1VSN271MP35S	
	1,000	25.4 × 35	0.15	2.40	EKMS181VSN102MQ35S	330	22 × 40	0.15	1.40	EKMS3B1VSN331MP40S	
	1,000	25.4 × 40	0.15	2.45	EKMS181VSN102MQ40S	330	25.4 × 30	0.15	1.38	EKMS3B1VSN331MQ30S	
	1,000	30 × 30	0.15	2.52	EKMS181VSN102MR30S	330	30 × 25	0.15	1.43	EKMS3B1VSN331MR25S	
	1,200	25.4 × 45	0.15	2.73	EKMS181VSN122MQ45S	390	22 × 45	0.15	1.56	EKMS3B1VSN391MP45S	
	1,200	30 × 35	0.15	2.83	EKMS181VSN122MR35S	390	22 × 50	0.15	1.59	EKMS3B1VSN391MP50S	
	1,200	35 × 25	0.15	2.91	EKMS181VSN122MA25S	390	25.4 × 35	0.15	1.57	EKMS3B1VSN391MQ35S	
	1,500	25.4 × 50	0.15	3.10	EKMS181VSN152MQ50S	470	25.4 × 40	0.15	1.76	EKMS3B1VSN471MQ40S	
	1,500	30 × 40	0.15	3.26	EKMS181VSN152MR40S	470	30 × 30	0.15	1.73	EKMS3B1VSN471MR30S	
	1,500	35 × 30	0.15	3.31	EKMS181VSN152MA30S	470	35 × 25	0.15	1.82	EKMS3B1VSN471MA25S	
	1,800	30 × 45	0.15	3.66	EKMS181VSN182MR45S	560	25.4 × 45	0.15	1.96	EKMS3B1VSN561MQ45S	
	1,800	35 × 35	0.15	3.68	EKMS181VSN182MA35S	560	25.4 × 50	0.15	1.99	EKMS3B1VSN561MQ50S	
2,200	30 × 50	0.15	4.11	EKMS181VSN222MR50S	560	30 × 35	0.15	1.93	EKMS3B1VSN561MR35S		
2,200	35 × 40	0.15	4.22	EKMS181VSN222MA40S	560	35 × 30	0.15	2.02	EKMS3B1VSN561MA30S		
2,700	35 × 45	0.15	4.78	EKMS181VSN272MA45S	680	30 × 40	0.15	2.19	EKMS3B1VSN681MR40S		
2,700	35 × 50	0.15	4.88	EKMS181VSN272MA50S	680	35 × 35	0.15	2.26	EKMS3B1VSN681MA35S		
200	390	22 × 25	0.15	1.34	EKMS201VSN391MP25S	820	30 × 45	0.15	2.47	EKMS3B1VSN821MR45S	
	470	22 × 30	0.15	1.54	EKMS201VSN471MP30S	820	30 × 50	0.15	2.51	EKMS3B1VSN821MR50S	
	560	22 × 35	0.15	1.72	EKMS201VSN561MP35S	820	35 × 40	0.15	2.57	EKMS3B1VSN821MA40S	
	560	25.4 × 25	0.15	1.67	EKMS201VSN561MQ25S	1,000	35 × 45	0.15	2.91	EKMS3B1VSN102MA45S	
	680	22 × 40	0.15	1.94	EKMS201VSN681MP40S	1,200	35 × 50	0.15	3.25	EKMS3B1VSN122MA50S	
	680	25.4 × 30	0.15	1.89	EKMS201VSN681MQ30S	120	22 × 25	0.15	0.77	EKMS401VSN121MP25S	
	820	22 × 45	0.15	2.17	EKMS201VSN821MP45S	150	22 × 30	0.15	0.90	EKMS401VSN151MP30S	
	820	25.4 × 35	0.15	2.17	EKMS201VSN821MQ35S	180	22 × 35	0.15	1.02	EKMS401VSN181MP35S	
	820	30 × 25	0.15	2.26	EKMS201VSN821MR25S	180	25.4 × 25	0.15	0.99	EKMS401VSN181MQ25S	
	1,000	22 × 50	0.15	2.45	EKMS201VSN102MP50S	220	22 × 40	0.15	1.15	EKMS401VSN221MP40S	
	1,000	25.4 × 40	0.15	2.45	EKMS201VSN102MQ40S	220	25.4 × 30	0.15	1.13	EKMS401VSN221MQ30S	
	1,000	30 × 30	0.15	2.52	EKMS201VSN102MR30S	270	22 × 45	0.15	1.29	EKMS401VSN271MP45S	
	1,000	35 × 25	0.15	2.66	EKMS201VSN102MA25S	270	25.4 × 35	0.15	1.30	EKMS401VSN271MQ35S	
	1,200	25.4 × 45	0.15	2.73	EKMS201VSN122MQ45S	270	30 × 25	0.15	1.29	EKMS401VSN271MR25S	
	1,200	25.4 × 50	0.15	2.78	EKMS201VSN122MQ50S	330	22 × 50	0.15	1.47	EKMS401VSN331MP50S	
	1,200	30 × 35	0.15	2.83	EKMS201VSN122MR35S	330	25.4 × 40	0.15	1.47	EKMS401VSN331MQ40S	
	1,200	35 × 30	0.15	2.96	EKMS201VSN122MA30S	330	30 × 30	0.15	1.45	EKMS401VSN331MR30S	
	1,500	30 × 40	0.15	3.26	EKMS201VSN152MR40S	330	35 × 25	0.15	1.52	EKMS401VSN331MA25S	
	1,500	35 × 35	0.15	3.36	EKMS201VSN152MA35S	390	25.4 × 45	0.15	1.63	EKMS401VSN391MQ45S	



New!

## KMS Series

### ◆STANDARD RATINGS

WV (Vdc)	Cap (μF)	Case size φD×L(mm)	tanδ	Rated ripple current (Arms/105°C,120Hz)	Part No.	WV (Vdc)	Cap (μF)	Case size φD×L(mm)	tanδ	Rated ripple current (Arms/105°C,120Hz)	Part No.
400	390	25.4 × 50	0.15	1.66	EKMS401VSN391MQ50S	420	390	35 × 35	0.20	1.71	EKMS421VSN391MA35S
	390	30 × 35	0.15	1.61	EKMS401VSN391MR35S		470	30 × 50	0.20	1.90	EKMS421VSN471MR50S
	470	30 × 40	0.15	1.82	EKMS401VSN471MR40S		470	35 × 40	0.20	1.95	EKMS421VSN471MA40S
	470	35 × 30	0.15	1.85	EKMS401VSN471MA30S		560	35 × 45	0.20	2.17	EKMS421VSN561MA45S
	560	30 × 45	0.15	2.04	EKMS401VSN561MR45S		680	35 × 50	0.20	2.45	EKMS421VSN681MA50S
	560	30 × 50	0.15	2.07	EKMS401VSN561MR50S		450	82	22 × 25	0.20	0.64
	560	35 × 35	0.15	2.05	EKMS401VSN561MA35S	120		22 × 30	0.20	0.81	EKMS451VSN121MP30S
	680	35 × 40	0.15	2.34	EKMS401VSN681MA40S	120		22 × 35	0.20	0.83	EKMS451VSN121MP35S
	680	35 × 45	0.15	2.40	EKMS401VSN681MA45S	120		25.4 × 25	0.20	0.81	EKMS451VSN121MQ25S
	820	35 × 50	0.15	2.69	EKMS401VSN821MA50S	150		22 × 40	0.20	0.94	EKMS451VSN151MP40S
420	100	22 × 25	0.20	0.70	EKMS421VSN101MP25S	150		25.4 × 30	0.20	0.93	EKMS451VSN151MQ30S
	120	22 × 30	0.20	0.81	EKMS421VSN121MP30S	180		22 × 45	0.20	1.06	EKMS451VSN181MP45S
	120	25.4 × 25	0.20	0.81	EKMS421VSN121MQ25S	180		25.4 × 35	0.20	1.06	EKMS451VSN181MQ35S
	150	22 × 35	0.20	0.93	EKMS421VSN151MP35S	180		30 × 25	0.20	1.06	EKMS451VSN181MR25S
	180	22 × 40	0.20	1.04	EKMS421VSN181MP40S	220		22 × 50	0.20	1.20	EKMS451VSN221MP50S
	180	25.4 × 30	0.20	1.02	EKMS421VSN181MQ30S	220		25.4 × 40	0.20	1.20	EKMS451VSN221MQ40S
	180	30 × 25	0.20	1.06	EKMS421VSN181MR25S	220		30 × 30	0.20	1.18	EKMS451VSN221MR30S
	220	22 × 45	0.20	1.17	EKMS421VSN221MP45S	220		35 × 25	0.20	1.24	EKMS451VSN221MA25S
	220	22 × 50	0.20	1.20	EKMS421VSN221MP50S	270		25.4 × 45	0.20	1.36	EKMS451VSN271MQ45S
	220	25.4 × 35	0.20	1.18	EKMS421VSN221MQ35S	270		25.4 × 50	0.20	1.38	EKMS451VSN271MQ50S
	220	30 × 30	0.20	1.18	EKMS421VSN221MR30S	270		30 × 35	0.20	1.34	EKMS451VSN271MR35S
	270	25.4 × 40	0.20	1.33	EKMS421VSN271MQ40S	270		35 × 30	0.20	1.40	EKMS451VSN271MA30S
	270	25.4 × 45	0.20	1.36	EKMS421VSN271MQ45S	330		30 × 40	0.20	1.52	EKMS451VSN331MR40S
	270	35 × 25	0.20	1.38	EKMS421VSN271MA25S	390		30 × 45	0.20	1.70	EKMS451VSN391MR45S
	330	25.4 × 50	0.20	1.52	EKMS421VSN331MQ50S	390		30 × 50	0.20	1.73	EKMS451VSN391MR50S
	330	30 × 35	0.20	1.48	EKMS421VSN331MR35S	390	35 × 35	0.20	1.71	EKMS451VSN391MA35S	
	330	30 × 40	0.20	1.52	EKMS421VSN331MR40S	470	35 × 40	0.20	1.95	EKMS451VSN471MA40S	
	330	35 × 30	0.20	1.55	EKMS421VSN331MA30S	470	35 × 45	0.20	1.99	EKMS451VSN471MA45S	
	390	30 × 45	0.20	1.70	EKMS421VSN391MR45S	560	35 × 50	0.20	2.22	EKMS451VSN561MA50S	

### ◆RATED RIPPLE CURRENT MULTIPLIERS

#### ●Frequency Multipliers

Frequency(Hz)	50	120	300	1k	10k	50k
160 to 250Vdc	0.81	1.00	1.17	1.32	1.45	1.50
315 to 450Vdc	0.77	1.00	1.16	1.30	1.41	1.43

The endurance of capacitors is reduced with internal heating produced by ripple current at the rate of halving the lifetime with every 5°C rise.

When long life performance is required in actual use, the rms ripple current has to be reduced.

# KMM Series

- Downsized, longer life, and high ripple version of KMH series
- Endurance with ripple current : 2,000 to 3,000 hours at 105°C
- Non solvent resistant type
- RoHS Compliant

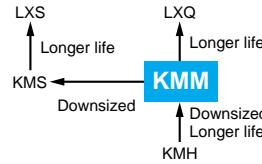

## SPECIFICATIONS

Items	Characteristics		
Category	-25 to +105°C		
Temperature Range	-25 to +105°C		
Rated Voltage Range	160 to 450V <sub>dc</sub>		
Capacitance Tolerance	±20% (M) (at 20°C, 120Hz)		
Leakage Current	I ≤ 3√CV Where, I : Max. leakage current (µA), C : Nominal capacitance (µF), V : Rated voltage (V) (at 20°C after 5 minutes)		
Dissipation Factor (tanδ)	Rated voltage (V <sub>dc</sub> )	160 to 400V	420 & 450V
	tanδ (Max.)	0.15	0.20
Low Temperature Characteristics (Max. Impedance Ratio)	Rated voltage (V <sub>dc</sub> )	160 to 400V	420 & 450V
	Z(-25°C)/Z(+20°C)	4	8
Endurance	The following specifications shall be satisfied when the capacitors are restored to 20°C after subjected to DC voltage with the rated ripple current is applied for 3,000 hours (2,000 hours for φ20×20L products) at 105°C.		
	Capacitance change	≤ ±20% of the initial value	
	D.F. (tanδ)	≤ 200% of the initial specified value	
	Leakage current	≤ The initial specified value	
Shelf Life	The following specifications shall be satisfied when the capacitors are restored to 20°C after exposing them for 1,000 hours at 105°C without voltage applied.		
	Capacitance change	≤ ±15% of the initial value	
	D.F. (tanδ)	≤ 150% of the initial specified value	
	Leakage current	≤ The initial specified value	

## DIMENSIONS [mm]

- Terminal Code : VS (φ20 to φ35) : Standard

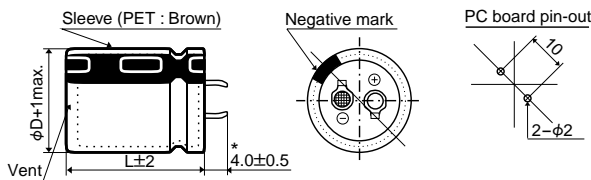

- Terminal Code : LI (φ35)

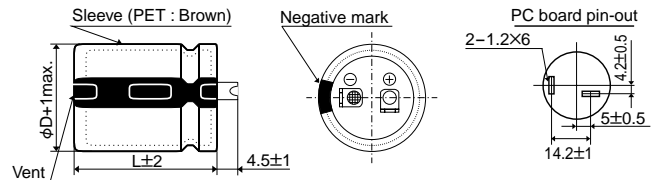

\*φD=35mm : 3.5±0.5mm

The standard design has no plastic disc.

## PART NUMBERING SYSTEM

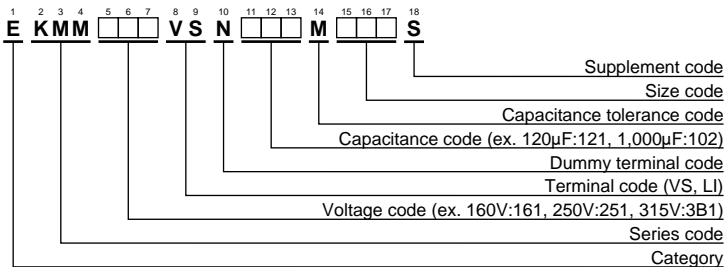

Please refer to "Product code guide (snap-in type)"

◆STANDARD RATINGS

WV (Vdc)	Cap (μF)	Case size φDXL(mm)	tanδ	Rated ripple current (Arms/105°C,120Hz)	Part No.	WV (Vdc)	Cap (μF)	Case size φDXL(mm)	tanδ	Rated ripple current (Arms/105°C,120Hz)	Part No.
160	180	20×20	0.15	0.68	EKMM161VSN181MN20S	180	560	20×45	0.15	1.55	EKMM181VSN561MN45S
	220	20×25	0.15	0.85	EKMM161VSN221MN25S		560	22×40	0.15	1.67	EKMM181VSN561MP40S
	220	22×20	0.15	0.81	EKMM161VSN221MP20S		560	25.4×30	0.15	1.67	EKMM181VSN561MQ30S
	270	20×25	0.15	1.10	EKMM161VSN271MN25S		560	30×25	0.15	1.67	EKMM181VSN561MR25S
	270	25.4×20	0.15	0.98	EKMM161VSN271MQ20S		560	35×20	0.15	1.43	EKMM181VSN561MA20S
	330	20×30	0.15	1.20	EKMM161VSN331MN30S		680	20×50	0.15	1.75	EKMM181VSN681MN50S
	330	22×25	0.15	1.20	EKMM161VSN331MP25S		680	22×45	0.15	1.78	EKMM181VSN681MP45S
	330	25.4×20	0.15	1.02	EKMM161VSN331MQ20S		680	25.4×35	0.15	1.78	EKMM181VSN681MQ35S
	390	20×30	0.15	1.30	EKMM161VSN391MN30S		680	30×30	0.15	1.78	EKMM181VSN681MR30S
	390	22×25	0.15	1.30	EKMM161VSN391MP25S		680	35×25	0.15	1.83	EKMM181VSN681MA25S
	390	25.4×25	0.15	1.26	EKMM161VSN391MQ25S		820	22×50	0.15	2.04	EKMM181VSN821MP50S
	390	30×20	0.15	1.25	EKMM161VSN391MR20S		820	25.4×40	0.15	2.04	EKMM181VSN821MQ40S
	470	20×35	0.15	1.34	EKMM161VSN471MN35S		820	30×30	0.15	2.04	EKMM181VSN821MR30S
	470	22×30	0.15	1.55	EKMM161VSN471MP30S		820	35×25	0.15	2.04	EKMM181VSN821MA25S
	470	25.4×25	0.15	1.55	EKMM161VSN471MQ25S		1,000	25.4×45	0.15	2.30	EKMM181VSN102MQ45S
	470	30×20	0.15	1.30	EKMM161VSN471MR20S		1,000	30×35	0.15	2.30	EKMM181VSN102MR35S
	560	20×40	0.15	1.50	EKMM161VSN561MN40S		1,000	35×30	0.15	2.30	EKMM181VSN102MA30S
	560	22×35	0.15	1.67	EKMM161VSN561MP35S		1,200	25.4×50	0.15	2.55	EKMM181VSN122MQ50S
	560	25.4×30	0.15	1.67	EKMM161VSN561MQ30S		1,200	30×40	0.15	2.55	EKMM181VSN122MR40S
	560	30×25	0.15	1.67	EKMM161VSN561MR25S		1,200	35×30	0.15	2.55	EKMM181VSN122MA30S
	560	35×20	0.15	1.46	EKMM161VSN561MA20S		1,500	30×45	0.15	2.90	EKMM181VSN152MR45S
	680	20×45	0.15	1.70	EKMM161VSN681MN45S		1,500	35×35	0.15	2.90	EKMM181VSN152MA35S
	680	22×40	0.15	1.82	EKMM161VSN681MP40S		1,800	30×60	0.15	3.49	EKMM181VSN182MR60S
	680	25.4×30	0.15	1.82	EKMM161VSN681MQ30S		1,800	35×40	0.15	3.30	EKMM181VSN182MA40S
	680	30×25	0.15	1.82	EKMM161VSN681MR25S		2,200	35×50	0.15	3.65	EKMM181VSN222MA50S
	680	35×20	0.15	1.51	EKMM161VSN681MA20S		2,700	35×60	0.15	4.19	EKMM181VSN272MA60S
	820	22×45	0.15	2.04	EKMM161VSN821MP45S		120	20×20	0.15	0.56	EKMM201VSN121MN20S
	820	25.4×35	0.15	2.04	EKMM161VSN821MQ35S		150	20×25	0.15	0.71	EKMM201VSN151MN25S
	820	30×30	0.15	2.04	EKMM161VSN821MR30S		150	22×20	0.15	0.73	EKMM201VSN151MP20S
	820	35×25	0.15	2.04	EKMM161VSN821MA25S		180	20×25	0.15	0.77	EKMM201VSN181MN25S
	1,000	22×50	0.15	2.25	EKMM161VSN102MP50S		180	22×20	0.15	0.80	EKMM201VSN181MP20S
	1,000	25.4×40	0.15	2.25	EKMM161VSN102MQ40S		220	20×25	0.15	1.00	EKMM201VSN221MN25S
	1,000	30×30	0.15	2.25	EKMM161VSN102MR30S		220	25.4×20	0.15	0.85	EKMM201VSN221MQ20S
	1,000	35×25	0.15	2.25	EKMM161VSN102MA25S		270	20×30	0.15	1.10	EKMM201VSN271MN30S
	1,200	25.4×45	0.15	2.49	EKMM161VSN122MQ45S		270	22×25	0.15	1.10	EKMM201VSN271MP25S
	1,200	30×35	0.15	2.49	EKMM161VSN122MR35S		270	30×20	0.15	1.05	EKMM201VSN271MR20S
	1,200	35×30	0.15	2.49	EKMM161VSN122MA30S		330	20×35	0.15	1.20	EKMM201VSN331MN35S
	1,500	25.4×60	0.15	2.97	EKMM161VSN152MQ60S		330	22×30	0.15	1.25	EKMM201VSN331MP30S
	1,500	30×40	0.15	2.84	EKMM161VSN152MR40S		330	25.4×25	0.15	1.25	EKMM201VSN331MQ25S
	1,500	35×30	0.15	2.84	EKMM161VSN152MA30S		330	30×20	0.15	1.10	EKMM201VSN331MR20S
1,800	30×45	0.15	3.32	EKMM161VSN182MR45S	390	20×40	0.15	1.31	EKMM201VSN391MN40S		
1,800	35×35	0.15	3.00	EKMM161VSN182MA35S	390	22×30	0.15	1.35	EKMM201VSN391MP30S		
2,200	30×60	0.15	3.86	EKMM161VSN222MR60S	390	25.4×25	0.15	1.35	EKMM201VSN391MQ25S		
2,200	35×45	0.15	3.50	EKMM161VSN222MA45S	390	35×20	0.15	1.30	EKMM201VSN391MA20S		
2,700	35×50	0.15	4.00	EKMM161VSN272MA50S	470	20×45	0.15	1.45	EKMM201VSN471MN45S		
3,300	35×60	0.15	4.63	EKMM161VSN332MA60S	470	22×35	0.15	1.50	EKMM201VSN471MP35S		
180	150	20×20	0.15	0.62	EKMM181VSN151MN20S	470	25.4×30	0.15	1.50	EKMM201VSN471MQ30S	
	180	20×25	0.15	0.77	EKMM181VSN181MN25S	470	30×25	0.15	1.50	EKMM201VSN471MR25S	
	180	22×20	0.15	0.80	EKMM181VSN181MP20S	470	35×20	0.15	1.41	EKMM201VSN471MA20S	
	220	20×25	0.15	1.00	EKMM181VSN221MN25S	560	20×50	0.15	1.58	EKMM201VSN561MN50S	
	220	25.4×20	0.15	0.90	EKMM181VSN221MQ20S	560	22×40	0.15	1.67	EKMM201VSN561MP40S	
	270	20×30	0.15	1.10	EKMM181VSN271MN30S	560	25.4×30	0.15	1.67	EKMM201VSN561MQ30S	
	270	22×25	0.15	1.00	EKMM181VSN271MP25S	560	30×25	0.15	1.67	EKMM201VSN561MR25S	
	270	25.4×20	0.15	0.95	EKMM181VSN271MQ20S	680	22×45	0.15	1.78	EKMM201VSN681MP45S	
	330	20×30	0.15	1.20	EKMM181VSN331MN30S	680	25.4×35	0.15	1.78	EKMM201VSN681MQ35S	
	330	22×25	0.15	1.20	EKMM181VSN331MP25S	680	30×30	0.15	1.78	EKMM201VSN681MR30S	
	330	25.4×25	0.15	1.16	EKMM181VSN331MQ25S	680	35×25	0.15	1.78	EKMM201VSN681MA25S	
	330	30×20	0.15	1.15	EKMM181VSN331MR20S	820	25.4×45	0.15	2.04	EKMM201VSN821MQ45S	
	390	20×35	0.15	1.30	EKMM181VSN391MN35S	820	30×30	0.15	2.04	EKMM201VSN821MR30S	
	390	22×30	0.15	1.35	EKMM181VSN391MP30S	820	35×25	0.15	2.04	EKMM201VSN821MA25S	
	390	25.4×25	0.15	1.35	EKMM181VSN391MQ25S	1,000	25.4×50	0.15	2.30	EKMM201VSN102MQ50S	
	390	30×20	0.15	1.20	EKMM181VSN391MR20S	1,000	30×35	0.15	2.30	EKMM201VSN102MR35S	
	470	20×40	0.15	1.40	EKMM181VSN471MN40S	1,000	35×30	0.15	2.30	EKMM201VSN102MA30S	
	470	22×35	0.15	1.50	EKMM181VSN471MP35S	1,200	25.4×60	0.15	2.66	EKMM201VSN122MQ60S	
	470	25.4×30	0.15	1.50	EKMM181VSN471MQ30S	1,200	30×40	0.15	2.65	EKMM201VSN122MR40S	
	470	30×25	0.15	1.50	EKMM181VSN471MR25S	1,200	35×35	0.15	2.65	EKMM201VSN122MA35S	
470	35×20	0.15	1.36	EKMM181VSN471MA20S	1,500	30×50	0.15	3.08	EKMM201VSN152MR50S		

### ◆STANDARD RATINGS

WV (Vdc)	Cap (μF)	Case size φD×L(mm)	tanδ	Rated ripple current (Arms/105°C,120Hz)	Part No.	WV (Vdc)	Cap (μF)	Case size φD×L(mm)	tanδ	Rated ripple current (Arms/105°C,120Hz)	Part No.	
200	1,500	35×40	0.15	3.08	EKMM201VSN152MA40S	250	330	30×25	0.15	1.30	EKMM251VSN331MR25S	
	1,800	30×60	0.15	3.49	EKMM201VSN182MR60S		330	35×20	0.15	1.16	EKMM251VSN331MA20S	
	1,800	35×45	0.15	3.48	EKMM201VSN182MA45S		390	20×50	0.15	1.45	EKMM251VSN391MN50S	
	2,200	35×50	0.15	3.78	EKMM201VSN222MA50S		390	22×40	0.15	1.49	EKMM251VSN391MP40S	
220	120	20×20	0.15	0.56	EKMM221VSN121MN20S		390	25.4×35	0.15	1.49	EKMM251VSN391MQ35S	
	150	20×25	0.15	0.73	EKMM221VSN151MN25S		390	30×25	0.15	1.49	EKMM251VSN391MR25S	
	150	22×20	0.15	0.67	EKMM221VSN151MP20S		470	22×45	0.15	1.65	EKMM251VSN471MP45S	
	180	20×25	0.15	0.90	EKMM221VSN181MN25S		470	25.4×35	0.15	1.65	EKMM251VSN471MQ35S	
	180	25.4×20	0.15	0.76	EKMM221VSN181MQ20S		470	30×30	0.15	1.65	EKMM251VSN471MR30S	
	220	20×30	0.15	1.00	EKMM221VSN221MN30S		470	35×25	0.15	1.65	EKMM251VSN471MA25S	
	220	22×25	0.15	1.00	EKMM221VSN221MP25S		560	22×50	0.15	1.67	EKMM251VSN561MP50S	
	220	25.4×20	0.15	0.84	EKMM221VSN221MQ20S		560	25.4×40	0.15	1.80	EKMM251VSN561MQ40S	
	270	20×35	0.15	1.15	EKMM221VSN271MN35S		560	30×30	0.15	1.80	EKMM251VSN561MR30S	
	270	22×30	0.15	1.15	EKMM221VSN271MP30S		560	35×25	0.15	1.80	EKMM251VSN561MA25S	
	270	25.4×25	0.15	1.08	EKMM221VSN271MQ25S		680	25.4×50	0.15	2.00	EKMM251VSN681MQ50S	
	270	30×20	0.15	0.98	EKMM221VSN271MR20S		680	30×35	0.15	2.00	EKMM251VSN681MR35S	
	330	20×40	0.15	1.25	EKMM221VSN331MN40S		680	35×30	0.15	2.00	EKMM251VSN681MA30S	
	330	22×35	0.15	1.25	EKMM221VSN331MP35S		820	25.4×60	0.15	2.20	EKMM251VSN821MQ60S	
	330	25.4×25	0.15	1.25	EKMM221VSN331MQ25S		820	30×40	0.15	2.30	EKMM251VSN821MR40S	
	330	35×20	0.15	1.13	EKMM221VSN331MA20S		820	35×35	0.15	2.30	EKMM251VSN821MA35S	
	390	20×45	0.15	1.40	EKMM221VSN391MN45S		1,000	30×50	0.15	2.47	EKMM251VSN102MR50S	
	390	22×35	0.15	1.40	EKMM221VSN391MP35S		1,000	35×40	0.15	2.47	EKMM251VSN102MA40S	
	390	25.4×30	0.15	1.40	EKMM221VSN391MQ30S		1,200	30×60	0.15	2.85	EKMM251VSN122MR60S	
	390	30×25	0.15	1.36	EKMM221VSN391MR25S		1,200	35×45	0.15	2.60	EKMM251VSN122MA45S	
	390	35×20	0.15	1.23	EKMM221VSN391MA20S		1,500	35×50	0.15	3.00	EKMM251VSN152MA50S	
	470	20×50	0.15	1.51	EKMM221VSN471MP50S		1,800	35×60	0.15	3.42	EKMM251VSN182MA60S	
	470	22×40	0.15	1.51	EKMM221VSN471MP40S		315	56	20×20	0.15	0.38	EKMM3B1VSN560MN20S
	470	25.4×35	0.15	1.54	EKMM221VSN471MQ35S			68	20×25	0.15	0.47	EKMM3B1VSN680MN25S
	470	30×25	0.15	1.50	EKMM221VSN471MR25S			68	22×20	0.15	0.45	EKMM3B1VSN680MP20S
	560	22×45	0.15	1.70	EKMM221VSN561MP45S			82	20×25	0.15	0.64	EKMM3B1VSN820MN25S
	560	25.4×40	0.15	1.72	EKMM221VSN561MQ40S			82	22×20	0.15	0.47	EKMM3B1VSN820MP20S
	560	30×30	0.15	1.70	EKMM221VSN561MR30S			100	20×30	0.15	0.69	EKMM3B1VSN101MN30S
	560	35×25	0.15	1.71	EKMM221VSN561MA25S			100	22×25	0.15	0.61	EKMM3B1VSN101MP25S
	680	25.4×45	0.15	1.94	EKMM221VSN681MQ45S			100	25.4×20	0.15	0.56	EKMM3B1VSN101MQ20S
	680	30×35	0.15	1.93	EKMM221VSN681MR35S			120	20×30	0.15	0.75	EKMM3B1VSN121MN30S
	680	35×25	0.15	1.89	EKMM221VSN681MA25S			120	22×25	0.15	0.75	EKMM3B1VSN121MP25S
	820	25.4×50	0.15	2.18	EKMM221VSN821MQ50S			120	25.4×20	0.15	0.62	EKMM3B1VSN121MQ20S
	820	30×40	0.15	2.19	EKMM221VSN821MR40S			120	30×20	0.15	0.65	EKMM3B1VSN121MR20S
	820	35×30	0.15	2.16	EKMM221VSN821MA30S			150	20×35	0.15	0.82	EKMM3B1VSN151MN35S
	1,000	25.4×60	0.15	2.54	EKMM221VSN102MQ60S			150	22×30	0.15	0.82	EKMM3B1VSN151MP30S
	1,000	30×45	0.15	2.50	EKMM221VSN102MR45S			150	25.4×25	0.15	0.82	EKMM3B1VSN151MQ25S
	1,000	35×35	0.15	2.44	EKMM221VSN102MA35S			150	30×20	0.15	0.70	EKMM3B1VSN151MR20S
	1,200	30×50	0.15	2.81	EKMM221VSN122MR50S			150	35×20	0.15	0.76	EKMM3B1VSN151MA20S
	1,200	35×40	0.15	2.79	EKMM221VSN122MA40S			180	20×40	0.15	0.90	EKMM3B1VSN181MN40S
1,500	30×60	0.15	3.30	EKMM221VSN152MR60S	180			22×35	0.15	0.92	EKMM3B1VSN181MP35S	
1,500	35×45	0.15	3.22	EKMM221VSN152MA45S	180			25.4×25	0.15	0.92	EKMM3B1VSN181MQ25S	
1,800	35×50	0.15	3.63	EKMM221VSN182MA50S	180			30×25	0.15	0.90	EKMM3B1VSN181MR25S	
2,200	35×60	0.15	4.23	EKMM221VSN222MA60S	180			35×20	0.15	0.85	EKMM3B1VSN181MA20S	
250	100	20×20	0.15	0.51	EKMM251VSN101MN20S	220		20×50	0.15	1.00	EKMM3B1VSN221MN50S	
	120	20×25	0.15	0.58	EKMM251VSN121MN25S	220		22×40	0.15	1.04	EKMM3B1VSN221MP40S	
	120	22×20	0.15	0.60	EKMM251VSN121MP20S	220		25.4×30	0.15	1.04	EKMM3B1VSN221MQ30S	
	150	20×25	0.15	0.79	EKMM251VSN151MN25S	220		30×25	0.15	1.04	EKMM3B1VSN221MR25S	
	150	25.4×20	0.15	0.74	EKMM251VSN151MQ20S	220		35×20	0.15	0.90	EKMM3B1VSN221MA20S	
	180	20×30	0.15	0.90	EKMM251VSN181MN30S	270		22×45	0.15	1.16	EKMM3B1VSN271MP45S	
	180	22×25	0.15	0.78	EKMM251VSN181MP25S	270		25.4×35	0.15	1.16	EKMM3B1VSN271MQ35S	
	180	25.4×20	0.15	0.75	EKMM251VSN181MQ20S	270		30×25	0.15	1.16	EKMM3B1VSN271MR25S	
	220	20×30	0.15	1.00	EKMM251VSN221MN30S	270		35×25	0.15	1.15	EKMM3B1VSN271MA25S	
	220	22×25	0.15	1.00	EKMM251VSN221MP25S	330		22×50	0.15	1.33	EKMM3B1VSN331MP50S	
	220	25.4×25	0.15	0.95	EKMM251VSN221MQ25S	330		25.4×40	0.15	1.33	EKMM3B1VSN331MQ40S	
	220	30×20	0.15	0.95	EKMM251VSN221MR20S	330		30×30	0.15	1.33	EKMM3B1VSN331MR30S	
	270	20×35	0.15	1.10	EKMM251VSN271MN35S	330		35×25	0.15	1.33	EKMM3B1VSN331MA25S	
	270	22×30	0.15	1.18	EKMM251VSN271MP30S	390		25.4×45	0.15	1.47	EKMM3B1VSN391MP45S	
	270	25.4×25	0.15	1.18	EKMM251VSN271MQ25S	390		30×35	0.15	1.47	EKMM3B1VSN391MR35S	
	270	30×20	0.15	1.00	EKMM251VSN271MR20S	390		35×30	0.15	1.47	EKMM3B1VSN391MA30S	
	330	20×40	0.15	1.20	EKMM251VSN331MN40S	470		25.4×50	0.15	1.70	EKMM3B1VSN471MQ50S	
	330	22×35	0.15	1.30	EKMM251VSN331MP35S	470		30×40	0.15	1.70	EKMM3B1VSN471MR40S	
	330	25.4×30	0.15	1.30	EKMM251VSN331MQ30S	470	35×30	0.15	1.70	EKMM3B1VSN471MA30S		

### ◆STANDARD RATINGS

WV (Vdc)	Cap (μF)	Case size φD×L(mm)	tanδ	Rated ripple current (Arms/105°C,120Hz)	Part No.	WV (Vdc)	Cap (μF)	Case size φD×L(mm)	tanδ	Rated ripple current (Arms/105°C,120Hz)	Part No.
315	560	30×45	0.15	2.05	EKMM3B1VSN561MR45S	400	100	30×20	0.15	0.60	EKMM401VSN101MR20S
	560	35×35	0.15	2.05	EKMM3B1VSN561MA35S		120	20×40	0.15	0.75	EKMM401VSN121MN40S
	680	30×50	0.15	2.17	EKMM3B1VSN681MR50S		120	22×35	0.15	0.75	EKMM401VSN121MP35S
	680	35×40	0.15	2.17	EKMM3B1VSN681MA40S		120	25.4×25	0.15	0.75	EKMM401VSN121MQ25S
	820	35×45	0.15	2.20	EKMM3B1VSN821MA45S		120	30×25	0.15	0.73	EKMM401VSN121MR25S
	1,000	35×60	0.15	2.55	EKMM3B1VSN102MA60S		120	35×20	0.15	0.75	EKMM401VSN121MA20S
350	47	20×20	0.15	0.35	EKMM351VSN470MN20S		150	20×45	0.15	0.83	EKMM401VSN151MN45S
	56	20×25	0.15	0.43	EKMM351VSN560MN25S		150	22×40	0.15	0.88	EKMM401VSN151MP40S
	56	22×20	0.15	0.41	EKMM351VSN560MP20S		150	25.4×30	0.15	0.88	EKMM401VSN151MQ30S
	68	20×25	0.15	0.47	EKMM351VSN680MN25S		150	30×25	0.15	0.88	EKMM401VSN151MR25S
	68	25.4×20	0.15	0.46	EKMM351VSN680MQ20S		150	35×20	0.15	0.80	EKMM401VSN151MA20S
	82	20×30	0.15	0.54	EKMM351VSN820MN30S		180	22×45	0.15	0.98	EKMM401VSN181MP45S
	82	22×25	0.15	0.55	EKMM351VSN820MP25S		180	25.4×35	0.15	0.98	EKMM401VSN181MQ35S
	82	25.4×20	0.15	0.51	EKMM351VSN820MQ20S		180	30×30	0.15	0.98	EKMM401VSN181MR30S
	100	20×30	0.15	0.60	EKMM351VSN101MN30S		180	35×25	0.15	0.98	EKMM401VSN181MA25S
	100	22×25	0.15	0.69	EKMM351VSN101MP25S		220	22×50	0.15	1.10	EKMM401VSN221MP50S
	100	30×20	0.15	0.60	EKMM351VSN101MR20S		220	25.4×40	0.15	1.10	EKMM401VSN221MQ40S
	120	20×35	0.15	0.68	EKMM351VSN121MN35S		220	30×30	0.15	1.10	EKMM401VSN221MR30S
	120	22×30	0.15	0.75	EKMM351VSN121MP30S		220	35×25	0.15	1.10	EKMM401VSN221MA25S
	120	25.4×25	0.15	0.75	EKMM351VSN121MQ25S		270	25.4×45	0.15	1.22	EKMM401VSN271MQ45S
	120	30×20	0.15	0.65	EKMM351VSN121MR20S		270	30×35	0.15	1.22	EKMM401VSN271MR35S
	150	20×40	0.15	0.78	EKMM351VSN151MN40S		270	35×30	0.15	1.22	EKMM401VSN271MA30S
	150	22×35	0.15	0.82	EKMM351VSN151MP35S		330	25.4×50	0.15	1.44	EKMM401VSN331MQ50S
	150	25.4×30	0.15	0.83	EKMM351VSN151MQ30S		330	30×40	0.15	1.44	EKMM401VSN331MR40S
	150	30×25	0.15	0.82	EKMM351VSN151MR25S		330	35×30	0.15	1.44	EKMM401VSN331MA30S
	150	35×20	0.15	0.76	EKMM351VSN151MA20S		390	25.4×60	0.15	1.51	EKMM401VSN391MQ60S
	180	20×45	0.15	0.87	EKMM351VSN181MN45S		390	30×45	0.15	1.60	EKMM401VSN391MR45S
	180	22×40	0.15	0.92	EKMM351VSN181MP40S		390	35×35	0.15	1.60	EKMM401VSN391MA35S
	180	25.4×30	0.15	0.92	EKMM351VSN181MQ30S		470	30×50	0.15	1.90	EKMM401VSN471MR50S
	180	30×25	0.15	0.90	EKMM351VSN181MR25S		470	35×40	0.15	1.90	EKMM401VSN471MA40S
	220	20×50	0.15	1.00	EKMM351VSN221MN50S		560	30×60	0.15	2.10	EKMM401VSN561MR60S
	220	22×45	0.15	1.05	EKMM351VSN221MP45S		560	35×45	0.15	2.12	EKMM401VSN561MA45S
	220	25.4×35	0.15	1.04	EKMM351VSN221MQ35S		680	35×60	0.15	2.27	EKMM401VSN681MA60S
	220	30×30	0.15	1.02	EKMM351VSN221MR30S		39	20×20	0.20	0.32	EKMM401VSN390MN20S
	220	35×25	0.15	1.04	EKMM351VSN221MA25S		47	20×25	0.20	0.39	EKMM421VSN470MN25S
	270	22×50	0.15	1.16	EKMM351VSN271MP50S		47	22×20	0.20	0.37	EKMM421VSN470MP20S
	270	25.4×40	0.15	1.18	EKMM351VSN271MQ40S		56	20×25	0.20	0.51	EKMM421VSN560MN25S
	270	30×30	0.15	1.17	EKMM351VSN271MR30S		56	25.4×20	0.20	0.42	EKMM401VSN560MQ20S
	270	35×25	0.15	1.20	EKMM351VSN271MA25S		68	20×30	0.20	0.56	EKMM421VSN680MN30S
	330	25.4×45	0.15	1.29	EKMM351VSN331MQ45S		68	22×25	0.20	0.50	EKMM421VSN680MP25S
	330	30×35	0.15	1.34	EKMM351VSN331MR35S		68	25.4×20	0.20	0.46	EKMM421VSN680MQ20S
	330	35×30	0.15	1.22	EKMM351VSN331MA30S		82	20×35	0.20	0.64	EKMM401VSN820MN35S
	390	25.4×50	0.15	1.51	EKMM351VSN391MQ50S	82	22×25	0.20	0.64	EKMM421VSN820MP25S	
	390	30×40	0.15	1.51	EKMM351VSN391MR40S	82	25.4×25	0.20	0.58	EKMM421VSN820MQ25S	
	390	35×35	0.15	1.47	EKMM351VSN391MA35S	82	30×20	0.20	0.53	EKMM421VSN820MR20S	
	470	25.4×60	0.15	1.66	EKMM351VSN471MQ60S	100	20×35	0.20	0.70	EKMM421VSN901MN35S	
	470	30×45	0.15	1.65	EKMM351VSN471MR45S	100	22×30	0.20	0.70	EKMM421VSN101MP30S	
	470	35×35	0.15	1.69	EKMM351VSN471MA35S	100	25.4×25	0.20	0.70	EKMM421VSN101MQ25S	
560	30×50	0.15	1.85	EKMM351VSN561MR50S	100	30×20	0.20	0.59	EKMM421VSN101MR20S		
560	35×40	0.15	1.90	EKMM351VSN561MA40S	120	20×40	0.20	0.75	EKMM421VSN121MN40S		
680	30×60	0.15	2.15	EKMM351VSN681MR60S	120	22×35	0.20	0.75	EKMM421VSN121MP35S		
680	35×50	0.15	1.99	EKMM351VSN681MA50S	120	25.4×30	0.20	0.75	EKMM421VSN121MQ30S		
820	35×60	0.15	2.31	EKMM351VSN821MA60S	120	30×25	0.20	0.73	EKMM421VSN121MR25S		
400	39	20×20	0.15	0.32	EKMM401VSN390MN20S	120	35×20	0.20	0.67	EKMM421VSN121MA20S	
	47	20×25	0.15	0.39	EKMM401VSN470MN25S	150	20×50	0.20	0.88	EKMM421VSN151MN50S	
	47	22×20	0.15	0.37	EKMM401VSN470MP20S	150	22×40	0.20	0.88	EKMM421VSN151MP40S	
	56	20×25	0.15	0.51	EKMM401VSN560MN25S	150	25.4×35	0.20	0.88	EKMM421VSN151MQ35S	
	56	25.4×20	0.15	0.42	EKMM401VSN560MQ20S	150	30×25	0.20	0.88	EKMM421VSN151MR25S	
	68	20×30	0.15	0.56	EKMM401VSN680MN30S	180	22×45	0.20	0.95	EKMM421VSN181MP45S	
	68	22×25	0.15	0.50	EKMM401VSN680MP25S	180	25.4×35	0.20	0.95	EKMM421VSN181MQ35S	
	68	25.4×20	0.15	0.46	EKMM401VSN680MQ20S	180	30×30	0.20	0.95	EKMM421VSN181MR30S	
	82	20×30	0.15	0.64	EKMM401VSN820MN30S	180	35×25	0.20	0.94	EKMM421VSN181MA25S	
	82	22×25	0.15	0.64	EKMM401VSN820MP25S	220	22×50	0.20	1.10	EKMM421VSN221MP50S	
	82	30×20	0.15	0.55	EKMM401VSN820MR20S	220	25.4×45	0.20	1.10	EKMM421VSN221MQ45S	
	100	20×35	0.15	0.70	EKMM401VSN101MN35S	220	30×35	0.20	1.10	EKMM421VSN221MR35S	
	100	22×30	0.15	0.70	EKMM401VSN101MP30S	220	35×25	0.20	1.10	EKMM421VSN221MA25S	
	100	25.4×25	0.15	0.70	EKMM401VSN101MQ25S	270	25.4×50	0.20	1.22	EKMM421VSN271MQ50S	

## KMM Series

### ◆STANDARD RATINGS

WV (V <sub>dc</sub> )	Cap (μF)	Case size φD×L(mm)	tanδ	Rated ripple current (A <sub>rms</sub> /105°C, 120Hz)	Part No.	WV (V <sub>dc</sub> )	Cap (μF)	Case size φD×L(mm)	tanδ	Rated ripple current (A <sub>rms</sub> /105°C, 120Hz)	Part No.
420	270	30×40	0.20	1.22	EKMM421VSN271MR40S	450	120	20×50	0.20	0.75	EKMM451VSN121MN50S
	270	35×30	0.20	1.22	EKMM421VSN271MA30S		120	22×40	0.20	0.80	EKMM451VSN121MP40S
	330	25.4×60	0.20	1.41	EKMM421VSN331MQ60S		120	25.4×30	0.20	0.80	EKMM451VSN121MQ30S
	330	30×45	0.20	1.45	EKMM421VSN331MR45S		120	30×25	0.20	0.80	EKMM451VSN121MR25S
	330	35×35	0.20	1.45	EKMM421VSN331MA35S		120	35×25	0.20	0.73	EKMM451VSN121MA25S
	390	30×50	0.20	1.55	EKMM421VSN391MR50S		150	22×45	0.20	0.88	EKMM451VSN151MP45S
	390	35×40	0.20	1.55	EKMM421VSN391MA40S		150	25.4×35	0.20	0.88	EKMM451VSN151MQ35S
	470	30×60	0.20	1.79	EKMM421VSN471MR60S		150	30×30	0.20	0.88	EKMM451VSN151MR30S
	470	35×45	0.20	1.90	EKMM421VSN471MA45S		150	35×25	0.20	0.75	EKMM451VSN151MA25S
	560	35×50	0.20	2.15	EKMM421VSN561MA50S		180	22×50	0.20	1.00	EKMM451VSN181MP50S
680	35×60	0.20	2.27	EKMM421VSN681MA60S	180		25.4×40	0.20	1.00	EKMM451VSN181MQ40S	
450	39	20×25	0.20	0.34	EKMM451VSN390MN25S		180	30×30	0.20	1.00	EKMM451VSN181MR30S
	47	20×25	0.20	0.39	EKMM451VSN470MN25S		220	25.4×45	0.20	1.12	EKMM451VSN221MQ45S
	56	20×30	0.20	0.51	EKMM451VSN560MN30S		220	30×35	0.20	1.12	EKMM451VSN221MR35S
	56	22×25	0.20	0.40	EKMM451VSN560MP25S		220	35×30	0.20	1.12	EKMM451VSN221MA30S
	68	20×35	0.20	0.56	EKMM451VSN680MN35S		270	25.4×60	0.20	1.18	EKMM451VSN271MQ60S
	68	22×30	0.20	0.53	EKMM451VSN680MP30S		270	30×40	0.20	1.28	EKMM451VSN271MR40S
	68	25.4×25	0.20	0.50	EKMM451VSN680MQ25S		270	35×35	0.20	1.28	EKMM451VSN271MA35S
	82	20×35	0.20	0.64	EKMM451VSN820MN35S		330	30×50	0.20	1.45	EKMM451VSN331MR50S
	82	22×30	0.20	0.64	EKMM451VSN820MP30S		330	35×40	0.20	1.45	EKMM451VSN331MA40S
	82	25.4×25	0.20	0.64	EKMM451VSN820MQ25S	390	30×60	0.20	1.51	EKMM451VSN391MR60S	
	100	20×45	0.20	0.69	EKMM451VSN101MN45S	390	35×40	0.20	1.55	EKMM451VSN391MA40S	
	100	22×35	0.20	0.69	EKMM451VSN101MP35S	470	35×50	0.20	1.85	EKMM451VSN471MA50S	
	100	25.4×30	0.20	0.69	EKMM451VSN101MQ30S	560	35×60	0.20	1.91	EKMM451VSN561MA60S	
	100	30×25	0.20	0.64	EKMM451VSN101MR25S						

### ◆RATED RIPPLE CURRENT MULTIPLIERS

#### ●Frequency Multipliers

Frequency (Hz)	50	120	300	1k	10k	50k
160 to 250V <sub>dc</sub>	0.81	1.00	1.17	1.32	1.45	1.50
315 to 450V <sub>dc</sub>	0.77	1.00	1.16	1.30	1.41	1.43

The endurance of capacitors is reduced with internal heating produced by ripple current at the rate of halving the lifetime with every 5°C rise. When long life performance is required in actual use, the rms ripple current has to be reduced.

# SMH Series

- Endurance with ripple current : 2,000 hours at 85°C
- Non solvent resistant type
- RoHS Compliant

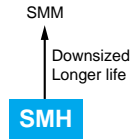

## ◆SPECIFICATIONS

Items	Characteristics										
Category	-40 to +85°C										
Temperature Range	-40 to +85°C										
Rated Voltage Range	6.3 to 100V <sub>dc</sub>										
Capacitance Tolerance	±20% (M) (at 20°C, 120Hz)										
Leakage Current	I=0.02CV or 3mA, whichever is smaller. Where, I : Max. leakage current (µA), C : Nominal capacitance (µF), V : Rated voltage (V) (at 20°C after 5 minutes)										
Dissipation Factor (tanδ)	Rated voltage (V <sub>dc</sub> )	6.3V	10V	16V	25V	35V	50V	63V	80V	100V	(at 20°C, 120Hz)
	tanδ (Max.)	0.60	0.50	0.40	0.30	0.25	0.20	0.15	0.15	0.15	
Low Temperature Characteristics (Max. Impedance Ratio)	Rated voltage (V <sub>dc</sub> )	6.3V	10V	16V	25V	35V	50V	63V	80V	100V	(at 120Hz)
	Z(-25°C)/Z(+20°C)	4	4	4	3	3	2	2	2	2	
	Z(-40°C)/Z(+20°C)	15	15	15	10	8	6	6	5	5	
Endurance	The following specifications shall be satisfied when the capacitors are restored to 20°C after subjected to DC voltage with the rated ripple current is applied for 2,000 hours at 85°C.										
	Capacitance change	≤±20% of the initial value									
	D.F. (tanδ)	≤200% of the initial specified value									
	Leakage current	≤The initial specified value									
Shelf Life	The following specifications shall be satisfied when the capacitors are restored to 20°C after exposing them for 1,000 hours at 85°C without voltage applied.										
	Capacitance change	≤±20% of the initial value									
	D.F. (tanδ)	≤150% of the initial specified value									
	Leakage current	≤The initial specified value									

## ◆DIMENSIONS [mm]

● Terminal Code : VS (φ22 to φ35) : Standard

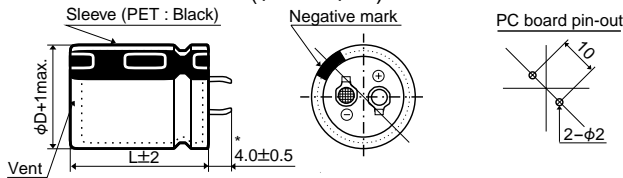

\*φD=35mm : 3.5±0.5mm

The standard design has no plastic disc.

● Terminal Code : LI (φ35)

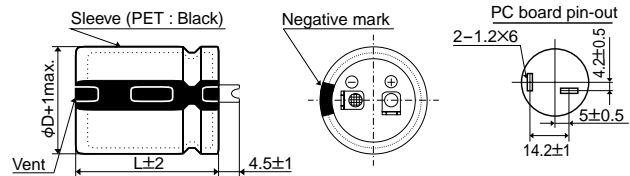

## ◆PART NUMBERING SYSTEM

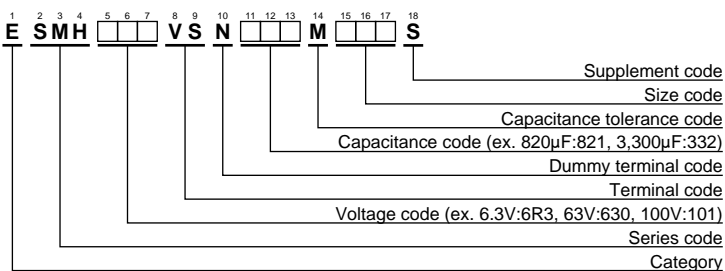

Please refer to "Product code guide (snap-in type)"



◆STANDARD RATINGS

WV (Vdc)	Cap (μF)	Case size φDXL(mm)	tanδ	Rated ripple current (Arms/85°C,120Hz)	Part No.	WV (Vdc)	Cap (μF)	Case size φDXL(mm)	tanδ	Rated ripple current (Arms/85°C,120Hz)	Part No.
6.3	15,000	22 × 25	0.60	2.44	ESMH6R3VSN153MP25S	16	27,000	25.4 × 45	0.40	4.72	ESMH160VSN273MQ45S
	18,000	22 × 30	0.60	2.67	ESMH6R3VSN183MP30S		27,000	30 × 35	0.40	4.82	ESMH160VSN273MR35S
	18,000	25.4 × 25	0.60	2.70	ESMH6R3VSN183MQ25S		27,000	35 × 30	0.40	4.65	ESMH160VSN273MA30S
	22,000	22 × 30	0.60	3.06	ESMH6R3VSN223MP30S		33,000	25.4 × 50	0.40	5.33	ESMH160VSN333MQ50S
	22,000	25.4 × 25	0.60	3.07	ESMH6R3VSN223MQ25S		33,000	30 × 40	0.40	5.36	ESMH160VSN333MR40S
	27,000	22 × 35	0.60	3.49	ESMH6R3VSN273MP35S		33,000	35 × 30	0.40	5.15	ESMH160VSN333MA30S
	27,000	25.4 × 30	0.60	3.52	ESMH6R3VSN273MQ30S		39,000	30 × 45	0.40	6.01	ESMH160VSN393MR45S
	27,000	30 × 25	0.60	3.57	ESMH6R3VSN273MR25S		39,000	35 × 35	0.40	5.95	ESMH160VSN393MA35S
	33,000	22 × 40	0.60	3.97	ESMH6R3VSN333MP40S		47,000	30 × 50	0.40	6.79	ESMH160VSN473MR50S
	33,000	25.4 × 35	0.60	4.02	ESMH6R3VSN333MQ35S		47,000	35 × 40	0.40	6.76	ESMH160VSN473MA40S
	33,000	30 × 25	0.60	3.95	ESMH6R3VSN333MR25S		56,000	35 × 45	0.40	7.62	ESMH160VSN563MA45S
	39,000	22 × 50	0.60	4.55	ESMH6R3VSN393MP50S		68,000	35 × 50	0.40	8.63	ESMH160VSN683MA50S
	39,000	25.4 × 40	0.60	4.50	ESMH6R3VSN393MQ40S		5,600	22 × 25	0.30	2.21	ESMH250VSN563MP25S
	39,000	30 × 30	0.60	4.45	ESMH6R3VSN393MR30S		6,800	22 × 30	0.30	2.40	ESMH250VSN682MP30S
	39,000	35 × 25	0.60	4.51	ESMH6R3VSN393MA25S		6,800	25.4 × 25	0.30	2.56	ESMH250VSN682MQ25S
	47,000	25.4 × 45	0.60	5.09	ESMH6R3VSN473MQ45S		8,200	22 × 35	0.30	2.72	ESMH250VSN822MP35S
	47,000	30 × 35	0.60	5.06	ESMH6R3VSN473MR35S		8,200	25.4 × 25	0.30	2.80	ESMH250VSN822MQ25S
	47,000	35 × 30	0.60	5.01	ESMH6R3VSN473MA30S		10,000	22 × 40	0.30	3.09	ESMH250VSN103MP40S
	56,000	25.4 × 50	0.60	5.71	ESMH6R3VSN563MQ50S		10,000	25.4 × 30	0.30	3.12	ESMH250VSN103MQ30S
	56,000	30 × 40	0.60	5.70	ESMH6R3VSN563MR40S		10,000	30 × 25	0.30	3.21	ESMH250VSN103MR25S
56,000	35 × 30	0.60	5.77	ESMH6R3VSN563MA30S	12,000	22 × 45	0.30	3.48	ESMH250VSN153MP45S		
68,000	30 × 45	0.60	6.48	ESMH6R3VSN683MR45S	12,000	25.4 × 35	0.30	3.43	ESMH250VSN123MQ35S		
68,000	35 × 35	0.60	6.42	ESMH6R3VSN683MA35S	12,000	30 × 30	0.30	3.86	ESMH250VSN123MR30S		
82,000	30 × 50	0.60	7.32	ESMH6R3VSN823MR50S	12,000	35 × 25	0.30	3.54	ESMH250VSN123MA25S		
82,000	35 × 40	0.60	7.29	ESMH6R3VSN823MA40S	15,000	22 × 50	0.30	4.00	ESMH250VSN153MP50S		
100,000	35 × 45	0.60	8.31	ESMH6R3VSN104MA45S	15,000	25.4 × 40	0.30	3.95	ESMH250VSN153MQ40S		
10	12,000	22 × 25	0.50	2.39	ESMH100VSN123MP25S	15,000	30 × 30	0.30	4.00	ESMH250VSN153MR30S	
	15,000	22 × 30	0.50	2.76	ESMH100VSN153MP30S	15,000	35 × 25	0.30	3.95	ESMH250VSN153MA25S	
	15,000	25.4 × 25	0.50	2.77	ESMH100VSN153MQ25S	18,000	25.4 × 45	0.30	4.45	ESMH250VSN183MQ45S	
	18,000	22 × 35	0.50	3.12	ESMH100VSN183MP35S	18,000	30 × 35	0.30	4.46	ESMH250VSN183MR35S	
	18,000	25.4 × 25	0.50	3.04	ESMH100VSN183MQ25S	18,000	35 × 30	0.30	4.63	ESMH250VSN183MA30S	
	22,000	22 × 40	0.50	3.55	ESMH100VSN223MP40S	22,000	25.4 × 50	0.30	5.02	ESMH250VSN223MQ50S	
	22,000	25.4 × 30	0.50	3.48	ESMH100VSN223MQ30S	22,000	30 × 45	0.30	5.21	ESMH250VSN223MR45S	
	22,000	30 × 25	0.50	3.53	ESMH100VSN223MR25S	22,000	35 × 35	0.30	5.16	ESMH250VSN223MA35S	
	27,000	22 × 45	0.50	4.04	ESMH100VSN273MP45S	27,000	30 × 50	0.30	5.94	ESMH250VSN273MR50S	
	27,000	25.4 × 35	0.50	3.98	ESMH100VSN273MQ35S	27,000	35 × 40	0.30	5.92	ESMH250VSN273MA40S	
	27,000	30 × 30	0.50	3.73	ESMH100VSN273MR30S	33,000	35 × 45	0.30	6.75	ESMH250VSN333MA45S	
	27,000	35 × 25	0.50	3.73	ESMH100VSN273MA25S	39,000	35 × 50	0.30	7.56	ESMH250VSN393MA50S	
	33,000	22 × 50	0.50	4.58	ESMH100VSN333MP50S	3,900	22 × 25	0.25	2.22	ESMH350VSN392MP25S	
	33,000	25.4 × 40	0.50	4.54	ESMH100VSN333MQ40S	4,700	22 × 30	0.25	2.41	ESMH350VSN472MP30S	
	33,000	30 × 30	0.50	4.13	ESMH100VSN333MR30S	4,700	25.4 × 25	0.25	2.42	ESMH350VSN472MQ25S	
	33,000	35 × 25	0.50	4.13	ESMH100VSN333MA25S	5,600	22 × 35	0.25	2.75	ESMH350VSN562MP35S	
	39,000	25.4 × 45	0.50	5.08	ESMH100VSN393MQ45S	5,600	25.4 × 25	0.25	2.64	ESMH350VSN562MQ25S	
	39,000	30 × 35	0.50	5.05	ESMH100VSN393MR35S	6,800	22 × 40	0.25	2.80	ESMH350VSN682MP40S	
	39,000	35 × 30	0.50	4.80	ESMH100VSN393MA35S	6,800	25.4 × 30	0.25	2.74	ESMH350VSN682MR30S	
	47,000	25.4 × 50	0.50	5.73	ESMH100VSN473MQ50S	6,800	30 × 25	0.25	2.97	ESMH350VSN682MR25S	
47,000	30 × 40	0.50	5.72	ESMH100VSN473MR40S	8,200	22 × 45	0.25	3.47	ESMH350VSN822MP45S		
47,000	35 × 30	0.50	5.27	ESMH100VSN473MA30S	8,200	25.4 × 35	0.25	3.10	ESMH350VSN822MQ35S		
56,000	30 × 45	0.50	6.44	ESMH100VSN563MR45S	8,200	30 × 30	0.25	3.13	ESMH350VSN822MR30S		
56,000	35 × 35	0.50	6.38	ESMH100VSN563MA35S	8,200	35 × 25	0.25	2.73	ESMH350VSN822MA25S		
68,000	30 × 50	0.50	7.27	ESMH100VSN683MR50S	10,000	22 × 50	0.25	3.57	ESMH350VSN103MP50S		
68,000	35 × 40	0.50	7.27	ESMH100VSN683MA40S	10,000	25.4 × 40	0.25	3.53	ESMH350VSN103MQ40S		
82,000	35 × 50	0.50	8.49	ESMH100VSN823MA50S	10,000	30 × 30	0.25	3.46	ESMH350VSN103MR30S		
16	8,200	22 × 25	0.40	2.51	ESMH160VSN822MP25S	10,000	35 × 25	0.25	3.02	ESMH350VSN103MA25S	
	10,000	22 × 25	0.40	2.77	ESMH160VSN103MP25S	12,000	25.4 × 45	0.25	3.98	ESMH350VSN123MQ45S	
	12,000	22 × 30	0.40	2.86	ESMH160VSN123MP30S	12,000	30 × 35	0.25	4.01	ESMH350VSN123MR35S	
	12,000	25.4 × 25	0.40	2.95	ESMH160VSN123MQ25S	12,000	35 × 30	0.25	4.42	ESMH350VSN123MA30S	
	15,000	22 × 35	0.40	3.29	ESMH160VSN153MP35S	15,000	25.4 × 50	0.25	4.54	ESMH350VSN123MQ50S	
	15,000	25.4 × 30	0.40	3.46	ESMH160VSN153MQ30S	15,000	30 × 40	0.25	4.52	ESMH350VSN153MR40S	
	15,000	30 × 25	0.40	3.66	ESMH160VSN153MR25S	15,000	35 × 35	0.25	5.01	ESMH350VSN153MA35S	
	18,000	22 × 40	0.40	3.72	ESMH160VSN183MP40S	18,000	30 × 45	0.25	4.71	ESMH350VSN183MR45S	
	18,000	25.4 × 35	0.40	3.98	ESMH160VSN183MQ35S	18,000	35 × 40	0.25	5.54	ESMH350VSN183MA40S	
	18,000	30 × 25	0.40	4.00	ESMH160VSN183MR25S	22,000	30 × 50	0.25	5.33	ESMH350VSN223MR50S	
	22,000	22 × 50	0.40	4.37	ESMH160VSN223MP50S	22,000	35 × 45	0.25	6.04	ESMH350VSN223MA45S	
	22,000	25.4 × 40	0.40	4.26	ESMH160VSN223MQ40S	27,000	35 × 50	0.25	6.89	ESMH350VSN273MA50S	
	22,000	30 × 30	0.40	4.21	ESMH160VSN223MR30S	2,200	22 × 25	0.20	1.91	ESMH500VSN222MP25S	
	22,000	35 × 25	0.40	4.15	ESMH160VSN223MA25S	3,300	22 × 30	0.20	2.37	ESMH500VSN332MP30S	



## ◆STANDARD RATINGS

WV (Vdc)	Cap (μF)	Case size φD×L(mm)	tanδ	Rated ripple current (Arms/85°C,120Hz)	Part No.	WV (Vdc)	Cap (μF)	Case size φD×L(mm)	tanδ	Rated ripple current (Arms/85°C,120Hz)	Part No.
50	3,300	25.4×25	0.20	2.38	ESMH500VSN332MQ25S	80	1,200	22×25	0.15	1.69	ESMH800VSN122MP25S
	3,900	22×35	0.20	2.65	ESMH500VSN392MP35S		1,500	22×25	0.15	1.88	ESMH800VSN152MP25S
	3,900	25.4×30	0.20	2.68	ESMH500VSN392MQ30S		1,800	22×30	0.15	2.14	ESMH800VSN182MP30S
	3,900	30×25	0.20	2.55	ESMH500VSN392MR25S		1,800	25.4×25	0.15	2.26	ESMH800VSN182MQ25S
	4,700	22×40	0.20	2.99	ESMH500VSN472MP40S		2,200	22×35	0.15	2.44	ESMH800VSN222MP35S
	4,700	25.4×35	0.20	3.03	ESMH500VSN472MQ35S		2,200	25.4×30	0.15	2.46	ESMH800VSN222MQ30S
	4,700	30×25	0.20	2.81	ESMH500VSN472MR25S		2,200	30×25	0.15	2.49	ESMH800VSN222MR25S
	5,600	22×45	0.20	3.36	ESMH500VSN562MP45S		2,700	22×40	0.15	2.78	ESMH800VSN272MP40S
	5,600	25.4×35	0.20	3.31	ESMH500VSN562MQ35S		2,700	25.4×35	0.15	2.81	ESMH800VSN272MQ35S
	5,600	30×30	0.20	3.37	ESMH500VSN562MR30S		2,700	30×25	0.15	2.75	ESMH800VSN272MR25S
	5,600	35×25	0.20	3.42	ESMH500VSN562MA25S		3,300	22×45	0.15	3.16	ESMH800VSN332MP45S
	6,800	22×50	0.20	3.81	ESMH500VSN682MP50S		3,300	25.4×40	0.15	3.21	ESMH800VSN332MQ40S
	6,800	25.4×40	0.20	3.81	ESMH500VSN682MQ40S		3,300	30×30	0.15	3.17	ESMH800VSN332MR30S
	6,800	30×35	0.20	3.85	ESMH500VSN682MR35S		3,300	35×25	0.15	3.21	ESMH800VSN332MA25S
	6,800	35×30	0.20	3.85	ESMH500VSN682MA30S		3,900	22×50	0.15	3.52	ESMH800VSN392MP50S
	8,200	25.4×50	0.20	4.37	ESMH500VSN822MQ50S		3,900	25.4×45	0.15	3.59	ESMH800VSN392MQ45S
	8,200	30×40	0.20	4.36	ESMH500VSN822MR40S		3,900	30×35	0.15	3.57	ESMH800VSN392MR35S
	8,200	35×30	0.20	4.41	ESMH500VSN822MA30S		3,900	35×25	0.15	3.50	ESMH800VSN392MA25S
10,000	30×45	0.20	4.97	ESMH500VSN103MR45S	4,700	25.4×50	0.15	4.05	ESMH800VSN472MQ50S		
10,000	35×35	0.20	4.92	ESMH500VSN103MA35S	4,700	30×40	0.15	4.05	ESMH800VSN472MR40S		
12,000	30×50	0.20	5.60	ESMH500VSN123MR50S	4,700	35×30	0.15	4.09	ESMH800VSN472MA30S		
12,000	35×40	0.20	5.58	ESMH500VSN123MA40S	5,600	30×45	0.15	4.55	ESMH800VSN562MR45S		
15,000	35×45	0.20	6.44	ESMH500VSN153MA45S	5,600	35×35	0.15	4.51	ESMH800VSN562MA35S		
18,000	35×50	0.20	6.71	ESMH500VSN183MA50S	6,800	30×50	0.15	5.16	ESMH800VSN682MR50S		
63	1,800	22×25	0.15	1.82	ESMH630VSN182MP25S	6,800	35×40	0.15	5.14	ESMH800VSN682MA40S	
	2,200	22×30	0.15	2.31	ESMH630VSN222MP30S	8,200	35×45	0.15	5.83	ESMH800VSN822MA45S	
	2,200	25.4×25	0.15	2.30	ESMH630VSN222MQ25S	10,000	35×50	0.15	6.63	ESMH800VSN103MA50S	
	2,700	22×35	0.15	2.40	ESMH630VSN272MP35S	820	22×25	0.15	1.86	ESMH101VSN821MP25S	
	2,700	25.4×25	0.15	2.40	ESMH630VSN272MQ25S	1,200	22×30	0.15	2.09	ESMH101VSN122MP30S	
	3,300	22×35	0.15	2.62	ESMH630VSN332MP35S	1,200	25.4×25	0.15	2.10	ESMH101VSN122MQ25S	
	3,300	25.4×30	0.15	2.64	ESMH630VSN332MQ30S	1,500	22×35	0.15	2.41	ESMH101VSN152MP35S	
	3,300	30×25	0.15	2.78	ESMH630VSN332MR25S	1,500	25.4×30	0.15	2.43	ESMH101VSN152MQ30S	
	3,900	22×40	0.15	2.93	ESMH630VSN392MP40S	1,500	30×25	0.15	2.46	ESMH101VSN152MR25S	
	3,900	25.4×35	0.15	2.97	ESMH630VSN392MQ35S	1,800	22×40	0.15	2.71	ESMH101VSN182MP40S	
	3,900	30×30	0.15	3.00	ESMH630VSN392MR30S	1,800	25.4×35	0.15	2.75	ESMH101VSN182MQ35S	
	3,900	35×25	0.15	3.00	ESMH630VSN392MA25S	1,800	30×25	0.15	2.72	ESMH101VSN182MR25S	
	4,700	22×50	0.15	3.39	ESMH630VSN472MP50S	2,200	22×45	0.15	3.08	ESMH101VSN222MP45S	
	4,700	25.4×40	0.15	3.36	ESMH630VSN472MQ40S	2,200	25.4×40	0.15	3.13	ESMH101VSN222MQ40S	
	4,700	30×30	0.15	3.32	ESMH630VSN472MR30S	2,200	30×30	0.15	3.09	ESMH101VSN222MR30S	
	4,700	35×25	0.15	3.36	ESMH630VSN472MA25S	2,200	35×25	0.15	3.14	ESMH101VSN222MA25S	
	5,600	25.4×45	0.15	3.77	ESMH630VSN562MQ45S	2,700	22×50	0.15	3.53	ESMH101VSN272MP50S	
	5,600	30×35	0.15	3.75	ESMH630VSN562MR35S	2,700	25.4×45	0.15	3.57	ESMH101VSN272MQ45S	
	5,600	35×30	0.15	3.76	ESMH630VSN562MA30S	2,700	30×35	0.15	3.55	ESMH101VSN272MR35S	
	6,800	25.4×50	0.15	4.27	ESMH630VSN682MQ50S	2,700	35×30	0.15	3.71	ESMH101VSN272MA30S	
	6,800	30×40	0.15	4.27	ESMH630VSN682MR40S	3,300	25.4×50	0.15	4.06	ESMH101VSN332MQ50S	
	6,800	35×30	0.15	4.15	ESMH630VSN682MA30S	3,300	30×40	0.15	4.05	ESMH101VSN332MR40S	
	8,200	30×45	0.15	4.83	ESMH630VSN822MR45S	3,300	35×30	0.15	4.05	ESMH101VSN332MA30S	
	8,200	35×35	0.15	4.79	ESMH630VSN822MA35S	3,900	30×45	0.15	4.54	ESMH101VSN392MR45S	
10,000	30×50	0.15	5.49	ESMH630VSN103MR50S	3,900	35×35	0.15	4.49	ESMH101VSN392MA35S		
10,000	35×40	0.15	5.47	ESMH630VSN103MA40S	4,700	30×50	0.15	5.13	ESMH101VSN472MR50S		
12,000	35×45	0.15	6.19	ESMH630VSN123MA45S	4,700	35×40	0.15	5.11	ESMH101VSN472MA40S		
					5,600	35×45	0.15	5.75	ESMH101VSN562MA45S		
					6,800	35×50	0.15	6.50	ESMH101VSN682MA50S		

\*For the rated voltage  $\geq 160V_{dc}$ , please use SMQ series

## ◆RATED RIPPLE CURRENT MULTIPLIERS

### ●Frequency Multipliers

Frequency (Hz)	50	120	300	1k	10k	50k
6.3 to 50V <sub>dc</sub>	0.95	1.00	1.03	1.05	1.08	1.08
63 to 100V <sub>dc</sub>	0.92	1.00	1.07	1.13	1.19	1.20

The endurance of capacitors is reduced with internal heating produced by ripple current at the rate of halving the lifetime with every 5°C rise. When long life performance is required in actual use, the rms ripple current has to be reduced.

# KMH Series

- Endurance with ripple current : 2,000 hours at 105°C
- Non solvent resistant type
- RoHS Compliant

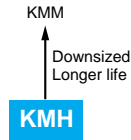

## ◆SPECIFICATIONS

Items	Characteristics										
Category	-40 to +105°C										
Temperature Range											
Rated Voltage Range	6.3 to 100V <sub>dc</sub>										
Capacitance Tolerance	±20% (M) (at 20°C, 120Hz)										
Leakage Current	I=0.02CV or 3mA, whichever is smaller Where, I : Max. leakage current (µA), C : Nominal capacitance (µF), V : Rated voltage (V) (at 20°C after 5 minutes)										
Dissipation Factor (tanδ)	Rated voltage (V <sub>dc</sub> )	6.3V	10V	16V	25V	35V	50V	63V	80V	100V	(at 20°C, 120Hz)
	tanδ (Max.)	0.60	0.50	0.40	0.30	0.25	0.20	0.15	0.15	0.15	
Low Temperature Characteristics (Max. Impedance Ratio)	Rated voltage (V <sub>dc</sub> )	6.3V	10V	16V	25V	35V	50V	63V	80V	100V	(at 120Hz)
	Z(-25°C)/Z(+20°C)	4	4	4	3	3	2	2	2	2	
	Z(-40°C)/Z(+20°C)	15	15	15	10	8	6	6	5	5	
Endurance	The following specifications shall be satisfied when the capacitors are restored to 20°C after subjected to DC voltage with the rated ripple current is applied for 2,000 hours at 105°C.										
	Capacitance change	≤±20% of the initial value									
	D.F. (tanδ)	≤200% of the initial specified value									
	Leakage current	≤The initial specified value									
Shelf Life	The following specifications shall be satisfied when the capacitors are restored to 20°C after exposing them for 1,000 hours at 105°C without voltage applied.										
	Capacitance change	≤±20% of the initial value									
	D.F. (tanδ)	≤150% of the initial specified value									
	Leakage current	≤The initial specified value									

## ◆DIMENSIONS [mm]

●Terminal Code : VS (φ22 to φ35) : Standard

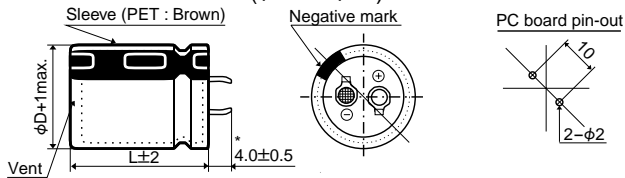

\*φD=35mm : 3.5±0.5mm

The standard design has no plastic disc.

●Terminal Code : LI (φ35)

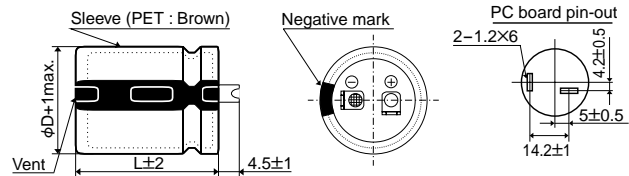

## ◆PART NUMBERING SYSTEM

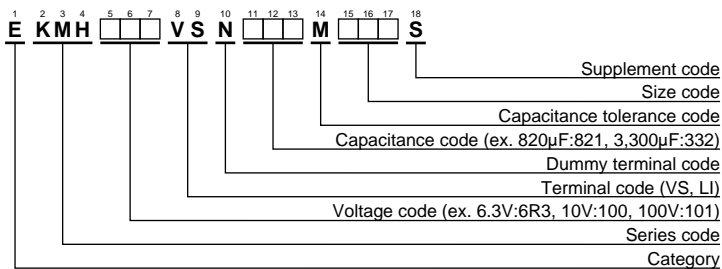

Please refer to "Product code guide (snap-in type)"



### ◆STANDARD RATINGS

WV (Vdc)	Cap (μF)	Case size φD×L(mm)	tanδ	Rated ripple current (Arms/105°C,120Hz)	Part No.	WV (Vdc)	Cap (μF)	Case size φD×L(mm)	tanδ	Rated ripple current (Arms/105°C,120Hz)	Part No.	
6.3	12,000	22×25	0.60	1.54	EKMH6R3VSN123MP25S	16	27,000	35×30	0.40	3.45	EKMH160VSN273MA30S	
	15,000	22×25	0.60	1.72	EKMH6R3VSN153MP25S		33,000	30×45	0.40	4.30	EKMH160VSN333MR45S	
	18,000	22×30	0.60	1.95	EKMH6R3VSN183MP30S		33,000	35×35	0.40	4.26	EKMH160VSN333MA35S	
	18,000	25.4×25	0.60	1.96	EKMH6R3VSN183MQ25S		39,000	30×50	0.40	4.81	EKMH160VSN393MR50S	
	22,000	22×35	0.60	2.23	EKMH6R3VSN223MP35S		39,000	35×40	0.40	4.79	EKMH160VSN393MA40S	
	22,000	25.4×30	0.60	2.25	EKMH6R3VSN223MQ30S		47,000	35×45	0.40	5.43	EKMH160VSN473MA45S	
	22,000	30×25	0.60	2.28	EKMH6R3VSN223MR25S		25	4,700	22×25	0.30	1.50	EKMH250VSN472MP25S
	27,000	22×40	0.60	2.54	EKMH6R3VSN273MP40S			5,600	22×25	0.30	1.63	EKMH250VSN562MP25S
	27,000	25.4×35	0.60	2.57	EKMH6R3VSN273MQ35S			6,800	22×30	0.30	1.86	EKMH250VSN682MP30S
	27,000	30×25	0.60	2.52	EKMH6R3VSN273MR25S			6,800	25.4×25	0.30	1.87	EKMH250VSN682MQ25S
	33,000	22×45	0.60	2.88	EKMH6R3VSN333MP45S			8,200	22×35	0.30	2.11	EKMH250VSN822MP35S
	33,000	25.4×40	0.60	2.93	EKMH6R3VSN333MQ40S			8,200	25.4×30	0.30	2.12	EKMH250VSN822MQ30S
	33,000	30×30	0.60	2.89	EKMH6R3VSN333MR30S			8,200	30×25	0.30	2.15	EKMH250VSN822MR25S
	33,000	35×25	0.60	2.93	EKMH6R3VSN333MA25S			10,000	22×40	0.30	2.39	EKMH250VSN103MP40S
	39,000	25.4×40	0.60	3.18	EKMH6R3VSN393MQ40S			10,000	25.4×35	0.30	2.42	EKMH250VSN103MQ35S
	39,000	30×35	0.60	3.26	EKMH6R3VSN393MR35S			10,000	30×25	0.30	2.37	EKMH250VSN103MR25S
	39,000	35×30	0.60	3.40	EKMH6R3VSN393MA30S			12,000	22×45	0.30	2.69	EKMH250VSN123MP45S
	47,000	25.4×50	0.60	3.69	EKMH6R3VSN473MQ50S			12,000	25.4×40	0.30	2.74	EKMH250VSN123MQ40S
	47,000	30×40	0.60	3.69	EKMH6R3VSN473MR40S			12,000	30×30	0.30	2.70	EKMH250VSN123MR30S
	47,000	35×30	0.60	3.73	EKMH6R3VSN473MA30S			12,000	35×25	0.30	2.74	EKMH250VSN123MA25S
	56,000	30×45	0.60	4.16	EKMH6R3VSN563MR45S			15,000	25.4×45	0.30	3.15	EKMH250VSN153MQ45S
	56,000	35×35	0.60	4.12	EKMH6R3VSN563MA35S			15,000	30×35	0.30	3.13	EKMH250VSN153MR35S
	68,000	30×50	0.60	4.71	EKMH6R3VSN683MR50S			15,000	35×30	0.30	3.27	EKMH250VSN153MA30S
	68,000	35×40	0.60	4.69	EKMH6R3VSN683MA40S			18,000	25.4×50	0.30	3.54	EKMH250VSN183MQ50S
82,000	35×45	0.60	5.32	EKMH6R3VSN823MA45S	18,000	30×40		0.30	3.54	EKMH250VSN183MR40S		
10	10,000	22×25	0.50	1.55	EKMH100VSN103MP25S	18,000		35×30	0.30	3.58	EKMH250VSN183MA30S	
	12,000	22×30	0.50	1.77	EKMH100VSN123MP30S	22,000		30×45	0.30	4.04	EKMH250VSN223MR45S	
	15,000	22×30	0.50	1.97	EKMH100VSN153MP30S	22,000		35×35	0.30	3.64	EKMH250VSN223MA35S	
	15,000	25.4×25	0.50	1.96	EKMH100VSN153MQ25S	27,000		35×45	0.30	4.73	EKMH250VSN273MA45S	
	18,000	22×35	0.50	2.21	EKMH100VSN183MP35S	33,000		35×50	0.30	5.39	EKMH250VSN333MA50S	
	18,000	25.4×30	0.50	2.23	EKMH100VSN183MQ30S	35	3,300	22×25	0.25	1.40	EKMH350VSN332MP25S	
	22,000	22×40	0.50	2.51	EKMH100VSN223MP40S		3,900	22×30	0.25	1.57	EKMH350VSN392MP30S	
	22,000	25.4×35	0.50	2.54	EKMH100VSN223MQ35S		4,700	22×30	0.25	1.72	EKMH350VSN472MP30S	
	22,000	30×25	0.50	2.40	EKMH100VSN223MR25S		4,700	25.4×25	0.25	1.80	EKMH350VSN472MQ25S	
	27,000	22×50	0.50	2.93	EKMH100VSN273MP50S		5,600	22×35	0.25	1.95	EKMH350VSN562MP35S	
	27,000	25.4×40	0.50	2.90	EKMH100VSN273MQ40S		5,600	25.4×30	0.25	1.96	EKMH350VSN562MQ30S	
	27,000	30×30	0.50	2.87	EKMH100VSN273MR30S		5,600	30×25	0.25	1.99	EKMH350VSN562MR25S	
	27,000	35×25	0.50	2.73	EKMH100VSN273MA25S		6,800	22×40	0.25	2.20	EKMH350VSN682MP40S	
	33,000	25.4×45	0.50	3.30	EKMH100VSN333MQ45S		6,800	25.4×35	0.25	2.23	EKMH350VSN682MQ35S	
	33,000	30×35	0.50	3.28	EKMH100VSN333MR35S		6,800	30×25	0.25	2.19	EKMH350VSN682MR25S	
	33,000	35×30	0.50	3.16	EKMH100VSN333MA30S		8,200	22×50	0.25	2.55	EKMH350VSN822MP50S	
	39,000	25.4×50	0.50	3.68	EKMH100VSN393MQ50S		8,200	25.4×40	0.25	2.53	EKMH350VSN822MQ40S	
	39,000	30×40	0.50	3.69	EKMH100VSN393MR40S		8,200	30×30	0.25	2.75	EKMH350VSN822MR30S	
	39,000	35×30	0.50	3.43	EKMH100VSN393MA30S		8,200	35×25	0.25	2.75	EKMH350VSN822MA25S	
	47,000	30×45	0.50	4.17	EKMH100VSN473MR45S		10,000	25.4×45	0.25	2.87	EKMH350VSN103MQ45S	
	47,000	35×35	0.50	3.76	EKMH100VSN473MA35S		10,000	30×35	0.25	2.90	EKMH350VSN103MR35S	
	56,000	30×50	0.50	4.68	EKMH100VSN563MR50S		10,000	35×30	0.25	2.91	EKMH350VSN103MA30S	
	56,000	35×40	0.50	4.67	EKMH100VSN563MA40S		12,000	25.4×50	0.25	3.24	EKMH350VSN123MQ50S	
	68,000	35×50	0.50	5.46	EKMH100VSN683MA50S		12,000	30×40	0.25	3.23	EKMH350VSN123MR40S	
16	6,800	22×25	0.40	1.57	EKMH160VSN682MP25S		12,000	35×30	0.25	2.99	EKMH350VSN123MA30S	
	10,000	22×30	0.40	1.97	EKMH160VSN103MP30S		15,000	30×45	0.25	3.72	EKMH350VSN153MR45S	
	1,000	25.4×25	0.40	1.97	EKMH160VSN103MQ25S		15,000	35×35	0.25	3.67	EKMH350VSN153MA35S	
	12,000	22×35	0.40	2.22	EKMH160VSN123MP35S		18,000	35×40	0.25	4.37	EKMH350VSN183MA40S	
	12,000	25.4×30	0.40	2.24	EKMH160VSN123MQ30S		22,000	35×50	0.25	4.92	EKMH350VSN223MA50S	
	12,000	30×25	0.40	2.45	EKMH160VSN123MR25S	50	1,800	22×25	0.20	1.33	EKMH500VSN182MP25S	
	15,000	22×40	0.40	2.55	EKMH160VSN153MP40S		2,700	22×30	0.20	1.69	EKMH500VSN272MP30S	
	15,000	25.4×35	0.40	2.58	EKMH160VSN153MQ35S		2,700	25.4×25	0.20	1.70	EKMH500VSN272MQ25S	
	15,000	30×25	0.40	2.52	EKMH160VSN153MR25S		3,300	22×35	0.20	1.93	EKMH500VSN332MP35S	
	18,000	22×45	0.40	2.87	EKMH160VSN183MP45S		3,300	25.4×30	0.20	1.85	EKMH500VSN332MQ30S	
	18,000	25.4×40	0.40	2.92	EKMH160VSN183MQ40S		3,900	22×40	0.20	2.16	EKMH500VSN392MP40S	
	18,000	30×30	0.40	2.88	EKMH160VSN183MR30S		3,900	25.4×35	0.20	2.18	EKMH500VSN392MQ35S	
	18,000	35×25	0.40	2.92	EKMH160VSN183MA25S		3,900	30×25	0.20	1.95	EKMH500VSN392MR25S	
	22,000	25.4×45	0.40	3.32	EKMH160VSN223MQ45S		4,700	22×45	0.20	2.43	EKMH500VSN472MP45S	
	22,000	30×35	0.40	3.29	EKMH160VSN223MR35S		4,700	25.4×35	0.20	2.39	EKMH500VSN472MQ35S	
	22,000	35×25	0.40	3.23	EKMH160VSN223MA25S		4,700	30×30	0.20	2.25	EKMH500VSN472MR30S	
	27,000	25.4×50	0.40	3.78	EKMH160VSN273MQ50S		4,700	35×25	0.20	2.48	EKMH500VSN472MA25S	
	27,000	30×40	0.40	3.77	EKMH160VSN273MR40S		5,600	22×50	0.20	2.75	EKMH500VSN562MP50S	

## ◆STANDARD RATINGS

WV (V <sub>dc</sub> )	Cap (μF)	Case size φD×L(mm)	tanδ	Rated ripple current (Arms/105°C, 120Hz)	Part No.	WV (V <sub>dc</sub> )	Cap (μF)	Case size φD×L(mm)	tanδ	Rated ripple current (Arms/105°C, 120Hz)	Part No.
50	5,600	25.4 × 40	0.20	2.70	EKMH500VSN562MQ40S	80	1,800	25.4 × 30	0.15	1.76	EKMH800VSN182MQ30S
	5,600	30 × 35	0.20	2.76	EKMH500VSN562MR35S		1,800	30 × 25	0.15	1.65	EKMH800VSN182MR25S
	5,600	35 × 25	0.20	2.70	EKMH500VSN562MA25S		2,200	22 × 45	0.15	2.04	EKMH800VSN222MP45S
	6,800	25.4 × 50	0.20	3.30	EKMH500VSN682MQ50S		2,200	25.4 × 35	0.15	2.01	EKMH800VSN222MQ35S
	6,800	30 × 40	0.20	3.30	EKMH500VSN682MR40S		2,200	30 × 30	0.15	2.05	EKMH800VSN222MR30S
	6,800	35 × 30	0.20	3.25	EKMH500VSN682MA30S		2,200	35 × 25	0.15	2.07	EKMH800VSN222MA25S
	8,200	30 × 45	0.20	3.60	EKMH500VSN822MR45S		2,700	25.4 × 45	0.15	2.36	EKMH800VSN272MQ45S
	8,200	35 × 35	0.20	3.55	EKMH500VSN822MA35S		2,700	30 × 35	0.15	2.35	EKMH800VSN272MR35S
	10,000	30 × 50	0.20	4.04	EKMH500VSN103MR50S		2,700	35 × 25	0.15	2.29	EKMH800VSN272MA25S
	10,000	35 × 40	0.20	4.03	EKMH500VSN103MA40S		3,300	25.4 × 50	0.15	2.68	EKMH800VSN332MQ50S
12,000	35 × 45	0.20	4.55	EKMH500VSN123MA45S	3,300	30 × 40	0.15	2.68	EKMH800VSN332MR40S		
63	1,200	22 × 25	0.15	1.19	EKMH630VSN122MP25S	3,300	35 × 30	0.15	2.45	EKMH800VSN332MA30S	
	1,500	22 × 25	0.15	1.33	EKMH630VSN152MP25S	3,900	30 × 45	0.15	3.00	EKMH800VSN392MR45S	
	1,800	22 × 30	0.15	1.51	EKMH630VSN182MP30S	3,900	35 × 35	0.15	2.98	EKMH800VSN392MA35S	
	1,800	25.4 × 25	0.15	1.52	EKMH630VSN182MQ25S	4,700	30 × 50	0.15	3.39	EKMH800VSN472MR50S	
	2,200	22 × 35	0.15	1.73	EKMH630VSN222MP35S	4,700	35 × 40	0.15	3.38	EKMH800VSN472MA40S	
	2,200	25.4 × 30	0.15	1.74	EKMH630VSN222MQ30S	5,600	35 × 45	0.15	3.80	EKMH800VSN562MA45S	
	2,700	22 × 40	0.15	1.97	EKMH630VSN272MP40S	6,800	35 × 50	0.15	3.90	EKMH800VSN682MA50S	
	2,700	25.4 × 35	0.15	1.99	EKMH630VSN272MQ35S	100	560	22 × 25	0.15	1.05	EKMH101VSN561MP25S
	2,700	30 × 25	0.15	1.76	EKMH630VSN272MR25S		820	22 × 30	0.15	1.32	EKMH101VSN821MP30S
	3,300	22 × 50	0.15	2.29	EKMH630VSN332MP50S		820	25.4 × 25	0.15	1.33	EKMH101VSN821MQ25S
	3,300	25.4 × 40	0.15	2.27	EKMH630VSN332MQ40S		1,000	22 × 35	0.15	1.50	EKMH101VSN102MP35S
	3,300	30 × 30	0.15	2.24	EKMH630VSN332MR30S		1,000	25.4 × 30	0.15	1.51	EKMH101VSN102MQ30S
	3,300	35 × 25	0.15	2.06	EKMH630VSN332MA25S		1,200	22 × 40	0.15	1.69	EKMH101VSN122MP40S
	3,900	25.4 × 45	0.15	2.54	EKMH630VSN392MQ45S		1,200	25.4 × 35	0.15	1.71	EKMH101VSN122MQ35S
	3,900	30 × 35	0.15	2.55	EKMH630VSN392MR35S		1,200	30 × 25	0.15	1.68	EKMH101VSN122MR25S
	3,900	35 × 25	0.15	2.24	EKMH630VSN392MA25S		1,500	22 × 45	0.15	1.94	EKMH101VSN152MP45S
	4,700	25.4 × 50	0.15	2.86	EKMH630VSN472MQ50S		1,500	25.4 × 40	0.15	1.98	EKMH101VSN152MQ40S
	4,700	30 × 40	0.15	2.86	EKMH630VSN472MR40S	1,500	30 × 30	0.15	1.95	EKMH101VSN152MR30S	
	4,700	35 × 30	0.15	2.79	EKMH630VSN472MA30S	1,500	35 × 25	0.15	1.98	EKMH101VSN152MA25S	
	5,600	30 × 45	0.15	3.22	EKMH630VSN562MR45S	1,800	25.4 × 45	0.15	2.23	EKMH101VSN182MQ45S	
5,600	35 × 35	0.15	3.19	EKMH630VSN562MA35S	1,800	30 × 35	0.15	2.50	EKMH101VSN182MR35S		
6,800	30 × 50	0.15	3.65	EKMH630VSN682MR50S	1,800	35 × 25	0.15	2.17	EKMH101VSN182MA25S		
6,800	35 × 40	0.15	3.64	EKMH630VSN682MA40S	2,200	25.4 × 50	0.15	2.53	EKMH101VSN222MQ50S		
8,200	35 × 45	0.15	3.90	EKMH630VSN822MA45S	2,200	30 × 40	0.15	2.70	EKMH101VSN222MR40S		
10,000	35 × 50	0.15	4.40	EKMH630VSN103MA50S	2,200	35 × 30	0.15	2.50	EKMH101VSN222MA30S		
80	820	22 × 25	0.15	1.11	EKMH800VSN821MP25S	2,700	30 × 45	0.15	2.88	EKMH101VSN272MR45S	
	1,000	22 × 25	0.15	1.22	EKMH800VSN102MP25S	2,700	35 × 35	0.15	2.86	EKMH101VSN272MA35S	
	1,200	22 × 30	0.15	1.38	EKMH800VSN122MP30S	3,300	30 × 50	0.15	3.28	EKMH101VSN332MR50S	
	1,200	25.4 × 25	0.15	1.39	EKMH800VSN122MQ25S	3,300	35 × 40	0.15	3.27	EKMH101VSN332MA40S	
	1,500	22 × 35	0.15	1.59	EKMH800VSN152MP35S	3,900	35 × 45	0.15	3.67	EKMH101VSN392MA45S	
	1,500	25.4 × 30	0.15	1.61	EKMH800VSN152MQ30S	4,700	35 × 50	0.15	3.80	EKMH101VSN472MA50S	
	1,800	22 × 40	0.15	1.80	EKMH800VSN182MP40S						

\*For the rated voltage  $\geq 160V_{dc}$ , please use KMR and KMQ series

## ◆RATED RIPPLE CURRENT MULTIPLIERS

### ●Frequency Multipliers

Frequency (Hz)	50	120	300	1k	10k	50k
6.3 to 50V <sub>dc</sub>	0.95	1.00	1.03	1.05	1.08	1.08
63 to 100V <sub>dc</sub>	0.92	1.00	1.07	1.13	1.19	1.20

The endurance of capacitors is reduced with internal heating produced by ripple current at the rate of halving the lifetime with every 5°C rise. When long life performance is required in actual use, the rms ripple current has to be reduced.

# SLM Series

- 15mm height snap-ins
- Endurance with ripple current : 2,000 hours at 85°C
- Non solvent resistant type
- RoHS Compliant

SLM

Low profile

SMH



## ◆ SPECIFICATIONS

Items	Characteristics	
Category	-25 to +85°C	
Temperature Range		
Rated Voltage Range	160 to 400V <sub>dc</sub>	
Capacitance Tolerance	±20% (M) (at 20°C, 120Hz)	
Leakage Current	I ≤ 3√CV Where, I : Max. leakage current (µA), C : Nominal capacitance (µF), V : Rated voltage (V) (at 20°C after 5 minutes)	
Dissipation Factor (tanδ)	Rated voltage (V <sub>dc</sub> )	160 to 400V
	tanδ (Max.)	0.20 (at 20°C, 120Hz)
Low Temperature Characteristics (Max. Impedance Ratio)	Rated voltage (V <sub>dc</sub> )	160 to 400V
	Z (-25°C) / Z (+20°C)	4 (at 120Hz)
Endurance	The following specifications shall be satisfied when the capacitors are restored to 20°C after subjected to DC voltage with the rated ripple current is applied for 2,000 hours at 85°C.	
	Capacitance change	≤ ±20% of the initial value
	D.F. (tanδ)	≤ 200% of the initial specified value
	Leakage current	≤ The initial specified value
Shelf Life	The following specifications shall be satisfied when the capacitors are restored to 20°C after exposing them for 1,000 hours at 85°C without voltage applied.	
	Capacitance change	≤ ±15% of the initial value
	D.F. (tanδ)	≤ 150% of the initial specified value
	Leakage current	≤ The initial specified value

## ◆ DIMENSIONS [mm]

- Terminal Code : VS

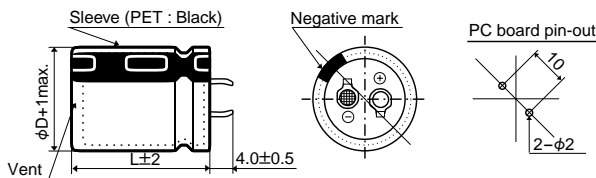

The standard design has no plastic disc.

## ◆ PART NUMBERING SYSTEM

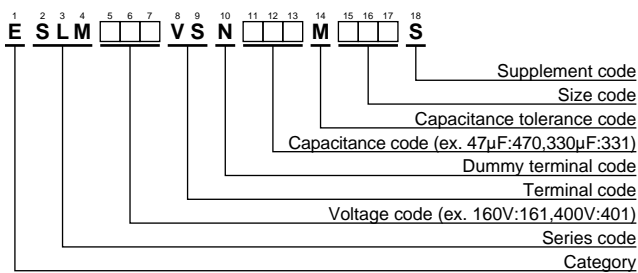

Please refer to "Product code guide (snap-in type)"

## ◆ RATED RIPPLE CURRENT MULTIPLIERS

- Frequency Multipliers

Frequency (Hz)	50	120	300	1k	10k	50k
160 to 250V <sub>dc</sub>	0.81	1.00	1.17	1.32	1.45	1.50
400V <sub>dc</sub>	0.77	1.00	1.16	1.30	1.41	1.43

The endurance of capacitors is reduced with internal heating produced by ripple current at the rate of halving the lifetime with every 5°C rise.

When long life performance is required in actual use, the rms ripple current has to be reduced.

## ◆ STANDARD RATINGS

WV (V <sub>dc</sub> )	Cap (µF)	Case size φD×L(mm)	tanδ	Rated ripple current (Arms/85°C,120Hz)	Part No.	WV (V <sub>dc</sub> )	Cap (µF)	Case size φD×L(mm)	tanδ	Rated ripple current (Arms/85°C,120Hz)	Part No.	
160	180	22 × 15	0.20	0.99	ESLM161VSN181MP15S	200	270	30 × 15	0.20	1.22	ESLM201VSN271MR15S	
	270	25.4 × 15	0.20	1.29	ESLM161VSN271MQ15S		390	35 × 15	0.20	1.46	ESLM201VSN391MA15S	
	390	30 × 15	0.20	1.47	ESLM161VSN391MR15S		250	100	22 × 15	0.20	0.73	ESLM251VSN101MP15S
	560	35 × 15	0.20	1.74	ESLM161VSN561MA15S			150	25.4 × 15	0.20	0.96	ESLM251VSN151MQ15S
180	150	22 × 15	0.20	0.90	ESLM181VSN151MP15S	220		30 × 15	0.20	1.10	ESLM251VSN221MR15S	
	220	25.4 × 15	0.20	1.16	ESLM181VSN221MQ15S	330	35 × 15	0.20	1.34	ESLM251VSN331MA15S		
	330	30 × 15	0.20	1.35	ESLM181VSN331MR15S	400	47	22 × 15	0.20	0.50	ESLM401VSN470MP15S	
470	35 × 15	0.20	1.60	ESLM181VSN471MA15S	68		25.4 × 15	0.20	0.65	ESLM401VSN680MQ15S		
200	150	22 × 15	0.20	0.90	ESLM201VSN151MP15S		100	30 × 15	0.20	0.74	ESLM401VSN101MR15S	
	220	25.4 × 15	0.20	1.16	ESLM201VSN221MQ15S		120	35 × 15	0.20	0.81	ESLM401VSN121MA15S	

# KLM Series

- 15mm height snap-ins
- Endurance with ripple current : 2,000 hours at 105°C
- Non solvent resistant type
- RoHS Compliant

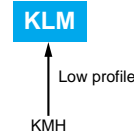

## ◆ SPECIFICATIONS

Items	Characteristics	
Category	-25 to +105°C	
Temperature Range		
Rated Voltage Range	160 to 400V <sub>dc</sub>	
Capacitance Tolerance	±20% (M) (at 20°C, 120Hz)	
Leakage Current	I ≤ 3√CV Where, I : Max. leakage current (µA), C : Nominal capacitance (µF), V : Rated voltage (V) (at 20°C after 5 minutes)	
Dissipation Factor (tanδ)	Rated voltage (V <sub>dc</sub> )	160 to 400V
	tanδ (Max.)	0.20 (at 20°C, 120Hz)
Low Temperature Characteristics (Max. Impedance Ratio)	Rated voltage (V <sub>dc</sub> )	160 to 400V
	Z (-25°C) / Z (+20°C)	4 (at 120Hz)
Endurance	The following specifications shall be satisfied when the capacitors are restored to 20°C after subjected to DC voltage with the rated ripple current is applied for 2,000 hours at 105°C.	
	Capacitance change	≤ ±20% of the initial value
	D.F. (tanδ)	≤ 200% of the initial specified value
	Leakage current	≤ The initial specified value
Shelf Life	The following specifications shall be satisfied when the capacitors are restored to 20°C after exposing them for 1,000 hours at 105°C without voltage applied.	
	Capacitance change	≤ ±15% of the initial value
	D.F. (tanδ)	≤ 150% of the initial specified value
	Leakage current	≤ The initial specified value

## ◆ DIMENSIONS [mm]

- Terminal Code : VS

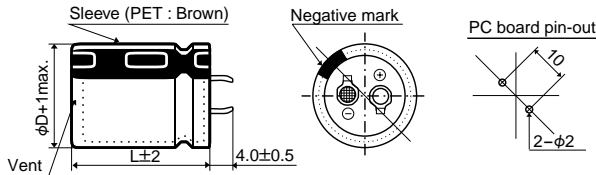

The standard design has no plastic disc.

## ◆ PART NUMBERING SYSTEM

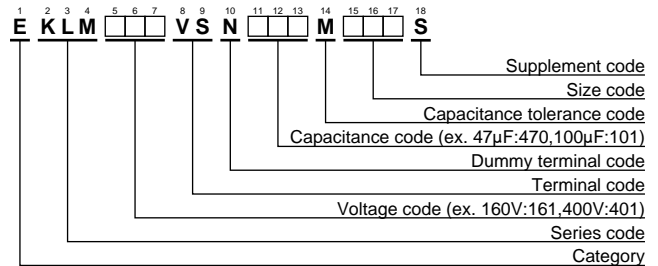

Please refer to "Product code guide (snap-in type)"

## ◆ STANDARD RATINGS

WV (V <sub>dc</sub> )	Cap (µF)	Case size φD×L(mm)	tanδ	Rated ripple current (Arms/105°C,120Hz)	Part No.
160	150	22 × 15	0.20	0.68	EKLM161VSN151MP15S
	180	25.4 × 15	0.20	0.79	EKLM161VSN181MQ15S
	220	25.4 × 15	0.20	0.88	EKLM161VSN221MQ15S
	270	30 × 15	0.20	0.96	EKLM161VSN271MR15S
	330	30 × 15	0.20	1.06	EKLM161VSN331MR15S
180	390	35 × 15	0.20	1.20	EKLM161VSN391MA15S
	120	22 × 15	0.20	0.61	EKLM181VSN121MP15S
	150	25.4 × 15	0.20	0.73	EKLM181VSN151MQ15S
	180	25.4 × 15	0.20	0.79	EKLM181VSN181MQ15S
	220	30 × 15	0.20	0.86	EKLM181VSN221MR15S
200	270	30 × 15	0.20	0.96	EKLM181VSN271MR15S
	330	35 × 15	0.20	1.10	EKLM181VSN331MA15S
	390	35 × 15	0.20	1.17	EKLM181VSN391MA15S
	120	22 × 15	0.20	0.61	EKLM201VSN121MP15S
	150	25.4 × 15	0.20	0.73	EKLM201VSN151MQ15S
250	180	30 × 15	0.20	0.79	EKLM201VSN181MR15S
	82	22 × 15	0.20	0.50	EKLM251VSN820MP15S
	100	25.4 × 15	0.20	0.59	EKLM251VSN101MQ15S
	120	25.4 × 15	0.20	0.65	EKLM251VSN121MQ15S
	150	30 × 15	0.20	0.71	EKLM251VSN151MR15S
400	180	30 × 15	0.20	0.79	EKLM251VSN181MR15S
	220	35 × 15	0.20	0.90	EKLM251VSN221MA15S
	39	22 × 15	0.20	0.35	EKLM401VSN390MP15S
	47	25.4 × 15	0.20	0.40	EKLM401VSN470MQ15S
	56	25.4 × 15	0.20	0.44	EKLM401VSN560MQ15S
400	68	30 × 15	0.20	0.46	EKLM401VSN680MR15S
	82	30 × 15	0.20	0.51	EKLM401VSN820MR15S
	100	35 × 15	0.20	0.56	EKLM401VSN101MA15S
	120	35 × 15	0.20	0.62	EKLM401VSN121MA15S

## ◆ RATED RIPPLE CURRENT MULTIPLIERS

- Frequency Multipliers

Frequency (Hz)	50	120	300	1k	10k	50k
160 to 250V <sub>dc</sub>	0.81	1.00	1.17	1.32	1.45	1.50
400V <sub>dc</sub>	0.77	1.00	1.16	1.30	1.41	1.43

The endurance of capacitors is reduced with internal heating caused by ripple current at the rate of halving the lifetime with every 5°C rise. When long life performance is required in actual use, the rms ripple current has to be reduced.

**LXM Series**

- Endurance with ripple current : 7,000 hours at 105°C
- Non solvent resistant type
- RoHS Compliant

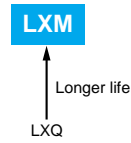

◆SPECIFICATIONS

Items	Characteristics		
Category	-25 to +105°C		
Temperature Range			
Rated Voltage Range	160 to 450V <sub>dc</sub>		
Capacitance Tolerance	±20% (M) (at 20°C, 120Hz)		
Leakage Current	I ≤ 3·C/V Where, I : Max. leakage current (µA), C : Nominal capacitance (µF), V : Rated voltage (V) (at 20°C after 5 minutes)		
Dissipation Factor (tanδ)	Rated voltage (V <sub>dc</sub> )	160 to 400V	420 & 450V
	tanδ (Max.)	0.15	0.20
		(at 20°C, 120Hz)	
Low Temperature Characteristics (Max. Impedance Ratio)	Rated voltage (V <sub>dc</sub> )	160 to 400V	420 & 450V
	Z(-25°C)/Z(+20°C)	4	8
		(at 120Hz)	
Endurance	The following specifications shall be satisfied when the capacitors are restored to 20°C after subjected to DC voltage with the rated ripple current is applied for 7,000 hours at 105°C.		
	Capacitance change	≤±20% of the initial value	
	D.F. (tanδ)	≤250% of the initial specified value	
	Leakage current	≤The initial specified value	
Shelf Life	The following specifications shall be satisfied when the capacitors are restored to 20°C after exposing them for 1,000 hours at 105°C without voltage applied.		
	Capacitance change	≤±15% of the initial value	
	D.F. (tanδ)	≤150% of the initial specified value	
	Leakage current	≤The initial specified value	

◆DIMENSIONS [mm]

●Terminal Code : VS (φ22 to φ35) : Standard

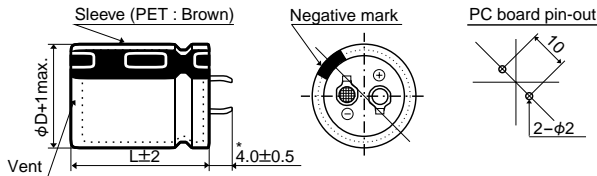

●Terminal Code : LI (φ35)

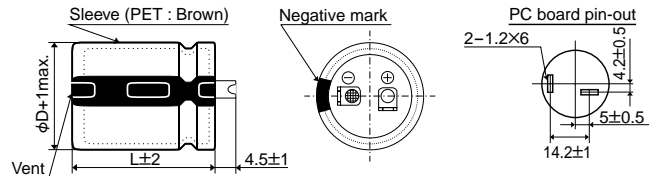

\*φD=35mm : 3.5±0.5mm

The standard design has no plastic disc.

◆PART NUMBERING SYSTEM

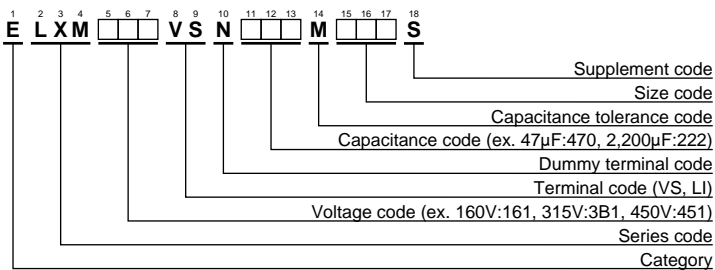

Please refer to "Product code guide (snap-in type)"



### ◆STANDARD RATINGS

WV (Vdc)	Cap (μF)	Case size φD×L(mm)	tanδ	Rated ripple current (Arms/105°C,120Hz)	Part No.	WV (Vdc)	Cap (μF)	Case size φD×L(mm)	tanδ	Rated ripple current (Arms/105°C,120Hz)	Part No.
160	330	22×25	0.15	1.11	ELXM161VSN331MP25S	220	220	22×25	0.15	0.90	ELXM221VSN221MP25S
	390	22×30	0.15	1.26	ELXM161VSN391MP30S		270	22×30	0.15	1.05	ELXM221VSN271MP30S
	470	22×30	0.15	1.39	ELXM161VSN471MP30S		330	22×35	0.15	1.19	ELXM221VSN331MP35S
	470	25.4×25	0.15	1.38	ELXM161VSN471MQ25S		330	25.4×25	0.15	1.16	ELXM221VSN331MQ25S
	560	22×35	0.15	1.55	ELXM161VSN561MP35S		390	22×40	0.15	1.33	ELXM221VSN391MP40S
	560	25.4×30	0.15	1.55	ELXM161VSN561MQ30S		390	25.4×30	0.15	1.29	ELXM221VSN391MQ30S
	680	22×40	0.15	1.75	ELXM161VSN681MP40S		470	22×45	0.15	1.49	ELXM221VSN471MP45S
	680	25.4×35	0.15	1.78	ELXM161VSN681MQ35S		470	25.4×35	0.15	1.48	ELXM221VSN471MQ35S
	680	30×25	0.15	1.74	ELXM161VSN681MR25S		470	30×25	0.15	1.45	ELXM221VSN471MR25S
	820	22×50	0.15	1.97	ELXM161VSN821MP50S		560	22×50	0.15	1.63	ELXM221VSN561MP50S
	820	25.4×40	0.15	2.01	ELXM161VSN821MQ40S		560	25.4×40	0.15	1.71	ELXM221VSN561MQ40S
	820	30×30	0.15	1.96	ELXM161VSN821MR30S		560	30×30	0.15	1.62	ELXM221VSN561MR30S
	1,000	25.4×45	0.15	2.27	ELXM161VSN102MQ45S		680	25.4×45	0.15	1.87	ELXM221VSN681MQ45S
	1,000	30×35	0.15	2.26	ELXM161VSN102MR35S		680	30×35	0.15	1.86	ELXM221VSN681MR35S
	1,200	25.4×50	0.15	2.54	ELXM161VSN122MQ50S		820	25.4×50	0.15	2.10	ELXM221VSN821MQ50S
	1,200	30×40	0.15	2.56	ELXM161VSN122MR40S		820	30×40	0.15	2.12	ELXM221VSN821MR40S
	1,200	35×30	0.15	2.52	ELXM161VSN122MA30S		820	35×30	0.15	2.08	ELXM221VSN821MA30S
	1,500	30×45	0.15	2.96	ELXM161VSN152MR45S		1,000	30×50	0.15	2.48	ELXM221VSN102MR50S
	1,500	35×35	0.15	2.89	ELXM161VSN152MA35S		1,000	35×40	0.15	2.46	ELXM221VSN102MA40S
	1,800	30×50	0.15	3.32	ELXM161VSN182MR50S		1,200	35×45	0.15	2.78	ELXM221VSN122MA45S
1,800	35×40	0.15	3.30	ELXM161VSN182MA40S	1,500	35×50	0.15	3.20	ELXM221VSN152MA50S		
2,200	35×50	0.15	3.87	ELXM161VSN222MA50S	250	180	22×25	0.15	0.82	ELXM251VSN181MP25S	
180	270	22×25	0.15	1.00		ELXM181VSN271MP25S	220	22×30	0.15	0.95	ELXM251VSN221MP30S
	330	22×30	0.15	1.16		ELXM181VSN331MP30S	270	22×35	0.15	1.08	ELXM251VSN271MP35S
	390	22×30	0.15	1.26		ELXM181VSN391MP30S	270	25.4×25	0.15	1.05	ELXM251VSN271MQ25S
	390	25.4×25	0.15	1.26		ELXM181VSN391MQ25S	330	22×40	0.15	1.22	ELXM251VSN331MP40S
	470	22×35	0.15	1.42		ELXM181VSN471MP35S	330	25.4×30	0.15	1.19	ELXM251VSN331MQ30S
	470	25.4×30	0.15	1.42		ELXM181VSN471MQ30S	390	22×45	0.15	1.36	ELXM251VSN391MP45S
	560	22×40	0.15	1.59		ELXM181VSN561MP40S	390	25.4×35	0.15	1.35	ELXM251VSN391MQ35S
	560	25.4×30	0.15	1.55		ELXM181VSN561MQ30S	390	30×25	0.15	1.32	ELXM251VSN391MR25S
	560	30×25	0.15	1.58		ELXM181VSN561MR25S	470	22×50	0.15	1.49	ELXM251VSN471MP50S
	680	22×45	0.15	1.79		ELXM181VSN681MP45S	470	25.4×40	0.15	1.52	ELXM251VSN471MQ40S
	680	25.4×35	0.15	1.78		ELXM181VSN681MQ35S	470	30×30	0.15	1.49	ELXM251VSN471MR30S
	680	30×30	0.15	1.79		ELXM181VSN681MR30S	560	25.4×45	0.15	1.70	ELXM251VSN561MP45S
	820	25.4×40	0.15	2.01		ELXM181VSN821MQ40S	560	30×35	0.15	1.69	ELXM251VSN561MR35S
	820	30×35	0.15	2.04		ELXM181VSN821MR35S	680	25.4×50	0.15	1.91	ELXM251VSN681MQ50S
	1,000	25.4×50	0.15	2.32		ELXM181VSN102MQ50S	680	30×40	0.15	1.93	ELXM251VSN681MR40S
	1,000	30×35	0.15	2.26		ELXM181VSN102MR35S	680	35×30	0.15	1.90	ELXM251VSN681MA30S
	1,000	35×30	0.15	2.30		ELXM181VSN102MA30S	820	30×45	0.15	2.19	ELXM251VSN821MR45S
	1,200	30×45	0.15	2.65		ELXM181VSN122MR45S	820	35×35	0.15	2.13	ELXM251VSN821MA35S
	1,200	35×35	0.15	2.58		ELXM181VSN122MA35S	1,000	35×40	0.15	2.46	ELXM251VSN102MA40S
	1,500	30×50	0.15	3.03	ELXM181VSN152MR50S	1,200	35×50	0.15	2.86	ELXM251VSN122MA50S	
1,500	35×40	0.15	3.01	ELXM181VSN152MA40S	315	100	22×25	0.15	0.67	ELXM3B1VSN101MP25S	
1,800	35×45	0.15	3.41	ELXM181VSN182MA45S		120	22×30	0.15	0.77	ELXM3B1VSN121MP30S	
2,200	35×50	0.15	3.87	ELXM181VSN222MA50S		150	22×30	0.15	0.86	ELXM3B1VSN151MP30S	
200	220	22×25	0.15	0.90		ELXM201VSN221MP25S	150	25.4×25	0.15	0.85	ELXM3B1VSN151MQ25S
	270	22×30	0.15	1.05		ELXM201VSN271MP30S	180	22×35	0.15	0.96	ELXM3B1VSN181MP35S
	330	22×30	0.15	1.16		ELXM201VSN331MP30S	180	25.4×30	0.15	0.96	ELXM3B1VSN181MQ30S
	330	25.4×25	0.15	1.16		ELXM201VSN331MQ25S	220	22×40	0.15	1.09	ELXM3B1VSN221MP40S
	390	22×35	0.15	1.29		ELXM201VSN391MP35S	220	25.4×30	0.15	1.06	ELXM3B1VSN221MQ30S
	390	25.4×30	0.15	1.29		ELXM201VSN391MQ30S	220	30×25	0.15	1.08	ELXM3B1VSN221MR25S
	470	22×40	0.15	1.46		ELXM201VSN471MP40S	270	22×45	0.15	1.24	ELXM3B1VSN271MP45S
	470	25.4×30	0.15	1.42		ELXM201VSN471MQ30S	270	25.4×35	0.15	1.23	ELXM3B1VSN271MQ35S
	470	30×25	0.15	1.45		ELXM201VSN471MR25S	270	30×30	0.15	1.23	ELXM3B1VSN271MR30S
	560	22×45	0.15	1.63		ELXM201VSN561MP45S	330	25.4×40	0.15	1.40	ELXM3B1VSN331MQ40S
	560	25.4×35	0.15	1.62		ELXM201VSN561MQ35S	330	30×35	0.15	1.42	ELXM3B1VSN331MR35S
	560	30×30	0.15	1.62		ELXM201VSN561MR30S	330	35×30	0.15	1.45	ELXM3B1VSN331MA30S
	680	25.4×40	0.15	1.83		ELXM201VSN681MQ40S	390	25.4×50	0.15	1.59	ELXM3B1VSN391MQ50S
	680	30×30	0.15	1.79		ELXM201VSN681MR30S	390	30×35	0.15	1.54	ELXM3B1VSN391MR35S
	820	25.4×45	0.15	2.06		ELXM201VSN821MQ45S	390	35×30	0.15	1.57	ELXM3B1VSN391MA30S
	820	30×35	0.15	2.04		ELXM201VSN821MR35S	470	30×45	0.15	1.81	ELXM3B1VSN471MR45S
	1,000	30×45	0.15	2.42		ELXM201VSN102MR45S	470	35×35	0.15	1.77	ELXM3B1VSN471MA35S
	1,000	35×30	0.15	2.30	ELXM201VSN102MA30S	560	30×50	0.15	2.03	ELXM3B1VSN561MR50S	
	1,200	30×50	0.15	2.71	ELXM201VSN122MR50S	560	35×40	0.15	2.02	ELXM3B1VSN561MA40S	
	1,200	35×40	0.15	2.70	ELXM201VSN122MA40S	680	35×45	0.15	2.29	ELXM3B1VSN681MA45S	
1,500	35×45	0.15	3.11	ELXM201VSN152MA45S	820	35×50	0.15	2.59	ELXM3B1VSN821MA50S		
1,800	35×50	0.15	3.50	ELXM201VSN182MA50S							



## ◆STANDARD RATINGS

WV (V <sub>dc</sub> )	Cap (μF)	Case size φD×L(mm)	tanδ	Rated ripple current (A <sub>rms</sub> /105°C,120Hz)	Part No.	WV (V <sub>dc</sub> )	Cap (μF)	Case size φD×L(mm)	tanδ	Rated ripple current (A <sub>rms</sub> /105°C,120Hz)	Part No.
350	100	22×25	0.15	0.67	ELXM351VSN101MP25S	420	56	22×25	0.20	0.50	ELXM421VSN560MP25S
	120	22×30	0.15	0.77	ELXM351VSN121MP30S		68	22×30	0.20	0.58	ELXM421VSN680MP30S
	120	25.4×25	0.15	0.76	ELXM351VSN121MQ25S		82	22×30	0.20	0.63	ELXM421VSN820MP30S
	150	22×35	0.15	0.88	ELXM351VSN151MP35S		82	25.4×25	0.20	0.63	ELXM421VSN820MQ25S
	150	25.4×30	0.15	0.88	ELXM351VSN151MQ30S		100	22×35	0.20	0.72	ELXM421VSN101MP35S
	180	22×40	0.15	0.99	ELXM351VSN181MP40S		100	25.4×30	0.20	0.72	ELXM421VSN101MQ30S
	180	25.4×30	0.15	0.96	ELXM351VSN181MQ30S		120	22×40	0.20	0.81	ELXM421VSN121MP40S
	180	30×25	0.15	0.98	ELXM351VSN181MR25S		120	25.4×30	0.20	0.79	ELXM421VSN121MQ30S
	220	22×45	0.15	1.12	ELXM351VSN221MP45S		120	30×25	0.20	0.80	ELXM421VSN121MR25S
	220	25.4×35	0.15	1.11	ELXM351VSN231MQ35S		150	22×45	0.20	0.92	ELXM421VSN151MR45S
	220	30×30	0.15	1.11	ELXM351VSN221MR30S		150	25.4×35	0.20	0.92	ELXM421VSN151MQ35S
	270	25.4×40	0.15	1.26	ELXM351VSN271MQ40S		150	30×30	0.20	0.92	ELXM421VSN151MR30S
	270	30×35	0.15	1.28	ELXM351VSN271MR35S		180	25.4×40	0.20	1.03	ELXM421VSN181MQ40S
	330	25.4×45	0.15	1.40	ELXM351VSN331MQ45S		180	30×35	0.20	1.05	ELXM421VSN181MR35S
	330	30×35	0.15	1.42	ELXM351VSN331MR35S		220	25.4×50	0.20	1.19	ELXM421VSN221MQ50S
	330	35×30	0.15	1.45	ELXM351VSN331MA30S		220	30×35	0.20	1.16	ELXM421VSN221MR35S
	390	30×40	0.15	1.60	ELXM351VSN391MR40S		220	35×30	0.20	1.18	ELXM421VSN221MA30S
	390	35×35	0.15	1.61	ELXM351VSN391MA35S		270	30×45	0.20	1.38	ELXM421VSN271MR45S
	470	30×50	0.15	1.86	ELXM351VSN471MR50S		270	35×35	0.20	1.34	ELXM421VSN271MA35S
	470	35×40	0.15	1.85	ELXM351VSN471MA40S		330	30×50	0.20	1.56	ELXM421VSN331MR50S
560	35×40	0.15	2.02	ELXM351VSN561MA40S	330	35×40	0.20	1.55	ELXM421VSN331MA40S		
680	35×50	0.15	2.36	ELXM351VSN681MA50S	390	35×45	0.20	1.74	ELXM421VSN391MA45S		
400	68	22×25	0.15	0.55	ELXM401VSN680MP25S	470	35×50	0.20	1.96	ELXM421VSN471MA50S	
	82	22×30	0.15	0.63	ELXM401VSN820MP30S	47	22×25	0.20	0.46	ELXM451VSN470MP25S	
	100	22×30	0.15	0.70	ELXM401VSN101MP30S	56	22×30	0.20	0.52	ELXM451VSN560MP30S	
	100	25.4×25	0.15	0.70	ELXM401VSN101MQ25S	68	22×30	0.20	0.58	ELXM451VSN680MP30S	
	120	22×35	0.15	0.79	ELXM401VSN121MP35S	68	25.4×25	0.20	0.58	ELXM451VSN680MQ25S	
	120	25.4×30	0.15	0.79	ELXM401VSN121MQ30S	82	22×35	0.20	0.65	ELXM451VSN820MP35S	
	150	22×40	0.15	0.90	ELXM401VSN151MP40S	82	25.4×30	0.20	0.65	ELXM451VSN820MQ30S	
	150	25.4×30	0.15	0.88	ELXM401VSN151MQ30S	100	22×40	0.20	0.74	ELXM451VSN101MP40S	
	150	30×25	0.15	0.90	ELXM401VSN151MR25S	100	25.4×30	0.20	0.72	ELXM451VSN101MQ30S	
	180	22×45	0.15	0.99	ELXM401VSN181MP45S	100	30×25	0.20	0.73	ELXM451VSN101MR25S	
	180	25.4×35	0.15	1.01	ELXM401VSN181MQ35S	120	22×45	0.20	0.83	ELXM451VSN121MP45S	
	180	30×30	0.15	1.01	ELXM401VSN181MR30S	120	25.4×35	0.20	0.82	ELXM451VSN121MQ35S	
	220	25.4×40	0.15	1.14	ELXM401VSN221MQ40S	120	30×30	0.20	0.82	ELXM451VSN121MR30S	
	220	30×35	0.15	1.16	ELXM401VSN221MR35S	150	25.4×40	0.20	0.94	ELXM451VSN151MQ40S	
	270	25.4×50	0.15	1.32	ELXM401VSN271MQ50S	150	30×35	0.20	0.96	ELXM451VSN151MR35S	
	270	30×40	0.15	1.33	ELXM401VSN271MR40S	180	25.4×45	0.20	1.06	ELXM451VSN181MQ45S	
	270	35×30	0.15	1.31	ELXM401VSN271MA30S	180	30×35	0.20	1.05	ELXM451VSN181MR35S	
	330	30×45	0.15	1.52	ELXM401VSN331MR45S	180	35×30	0.20	1.07	ELXM451VSN181MA30S	
	330	35×35	0.15	1.48	ELXM401VSN331MA35S	220	30×40	0.20	1.20	ELXM451VSN221MR40S	
	390	30×50	0.15	1.69	ELXM401VSN391MR50S	220	35×35	0.20	1.21	ELXM451VSN221MA35S	
390	35×40	0.15	1.68	ELXM401VSN391MA40S	270	30×50	0.20	1.41	ELXM451VSN271MR50S		
470	35×45	0.15	1.91	ELXM401VSN471MA45S	270	35×40	0.20	1.40	ELXM451VSN271MA40S		
560	35×50	0.15	2.14	ELXM401VSN561MA50S	330	35×45	0.20	1.60	ELXM451VSN331MA45S		
					390	35×50	0.20	1.79	ELXM451VSN391MA50S		

## ◆RATED RIPPLE CURRENT MULTIPLIERS

### ●Frequency Multipliers

Frequency(Hz)	50	120	300	1k	10k	50k
160 to 250V <sub>dc</sub>	0.81	1.00	1.17	1.32	1.45	1.50
315 to 450V <sub>dc</sub>	0.77	1.00	1.16	1.30	1.41	1.43

The endurance of capacitors is reduced with internal heating produced by ripple current at the rate of halving the lifetime with every 5°C rise. When long life performance is required in actual use, the rms ripple current has to be reduced.

New!  
**LXS Series**

- Endurance with ripple current : 5,000 hours at 105°C
- Downsized from LXQ series
- Non solvent resistant type
- RoHS Compliant

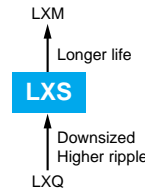

◆SPECIFICATIONS

Items	Characteristics		
Category	-25 to +105°C		
Temperature Range			
Rated Voltage Range	160 to 450V <sub>dc</sub>		
Capacitance Tolerance	±20% (M) (at 20°C, 120Hz)		
Leakage Current	I ≤ 3·C/V Where, I : Max. leakage current (µA), C : Nominal capacitance (µF), V : Rated voltage (V) (at 20°C after 5 minutes)		
Dissipation Factor (tanδ)	Rated voltage (V <sub>dc</sub> )	160 to 400V	420 & 450V
	tanδ (Max.)	0.15	0.20
Low Temperature Characteristics (Max. Impedance Ratio)	Rated voltage (V <sub>dc</sub> )	160 to 400V	420 & 450V
	Z(-25°C)/Z(+20°C)	4	8
Endurance	The following specifications shall be satisfied when the capacitors are restored to 20°C after subjected to DC voltage with the rated ripple current is applied for 5,000 hours at 105°C.		
	Capacitance change	≤±20% of the initial value	
	D.F. (tanδ)	≤200% of the initial specified value	
	Leakage current	≤The initial specified value	
Shelf Life	The following specifications shall be satisfied when the capacitors are restored to 20°C after exposing them for 1,000 hours at 105°C without voltage applied.		
	Capacitance change	≤±15% of the initial value	
	D.F. (tanδ)	≤150% of the initial specified value	
	Leakage current	≤The initial specified value	

◆DIMENSIONS [mm]

●Terminal Code : VS (φ22 to φ35) : Standard

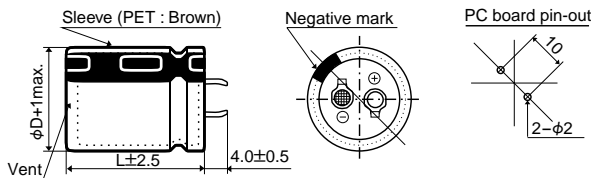

●Terminal Code : LI (φ30, φ35)

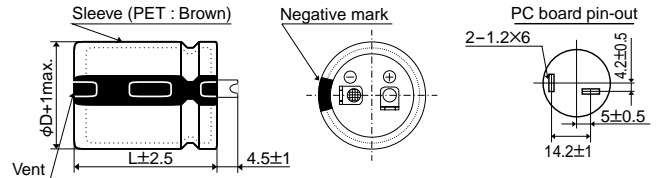

The standard design has no plastic disc.

◆PART NUMBERING SYSTEM

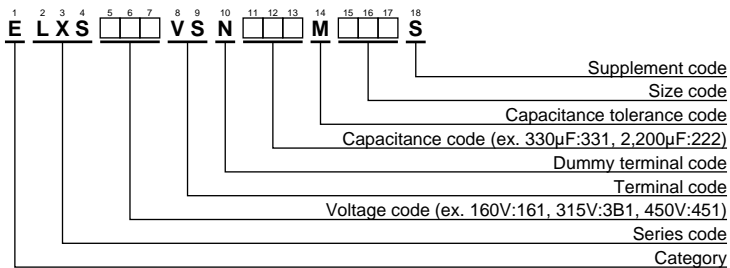

Please refer to "Product code guide (snap-in type)"

◆STANDARD RATINGS

WV (Vdc)	Cap (μF)	Case size φD×L(mm)	tanδ	Rated ripple current (Arms/105°C,120Hz)	Part No.	WV (Vdc)	Cap (μF)	Case size φD×L(mm)	tanδ	Rated ripple current (Arms/105°C,120Hz)	Part No.		
160	470	22×25	0.15	1.47	ELXS161VSN471MP25S	200	1,500	35×35	0.15	3.36	ELXS201VSN152MA35S		
	680	22×30	0.15	1.86	ELXS161VSN681MP30S		1,800	30×50	0.15	3.72	ELXS201VSN182MR50S		
	680	25.4×25	0.15	1.84	ELXS161VSN681MQ25S		1,800	35×40	0.15	3.81	ELXS201VSN182MA40S		
	820	22×35	0.15	2.09	ELXS161VSN821MP35S		2,200	35×45	0.15	4.32	ELXS201VSN222MA45S		
	820	25.4×30	0.15	2.08	ELXS161VSN821MQ30S		2,700	35×50	0.15	4.88	ELXS201VSN272MA50S		
	1,000	22×40	0.15	2.35	ELXS161VSN102MP40S		250	270	22×25	0.15	1.11	ELXS251VSN271MP25S	
	1,000	22×45	0.15	2.40	ELXS161VSN102MP45S			330	22×30	0.15	1.29	ELXS251VSN331MP30S	
	1,000	25.4×35	0.15	2.40	ELXS161VSN102MQ35S			390	22×35	0.15	1.44	ELXS251VSN391MP35S	
	1,000	30×25	0.15	2.50	ELXS161VSN102MR25S			390	25.4×25	0.15	1.40	ELXS251VSN391MQ25S	
	1,200	22×50	0.15	2.69	ELXS161VSN122MP50S			470	22×40	0.15	1.61	ELXS251VSN471MP40S	
	1,200	25.4×40	0.15	2.68	ELXS161VSN122MQ40S			470	25.4×30	0.15	1.57	ELXS251VSN471MQ30S	
	1,200	30×30	0.15	2.77	ELXS161VSN122MR30S			560	22×45	0.15	1.79	ELXS251VSN561MP45S	
	1,200	35×25	0.15	2.91	ELXS161VSN122MA25S			560	25.4×35	0.15	1.79	ELXS251VSN561MQ35S	
	1,500	25.4×45	0.15	3.05	ELXS161VSN122MA45S			560	30×25	0.15	1.87	ELXS251VSN681MA25S	
	1,500	30×35	0.15	3.17	ELXS161VSN152MR35S			680	22×50	0.15	2.02	ELXS251VSN681MP50S	
	1,800	25.4×50	0.15	3.40	ELXS161VSN182MQ50S			680	25.4×40	0.15	2.02	ELXS251VSN681MQ40S	
	1,800	30×40	0.15	3.57	ELXS161VSN182MR40S			680	30×30	0.15	2.08	ELXS251VSN681MR30S	
	1,800	35×30	0.15	3.62	ELXS161VSN182MA30S			680	35×25	0.15	2.19	ELXS251VSN681MA25S	
	2,200	30×45	0.15	4.05	ELXS161VSN222MR45S			820	25.4×45	0.15	2.26	ELXS251VSN821MQ45S	
	2,200	30×50	0.15	4.11	ELXS161VSN222MR50S			820	25.4×50	0.15	2.29	ELXS251VSN821MQ50S	
	2,200	35×35	0.15	4.07	ELXS161VSN222MA35S			820	30×35	0.15	2.34	ELXS251VSN821MR35S	
	2,700	35×40	0.15	4.67	ELXS161VSN272MA40S			820	35×30	0.15	2.45	ELXS251VSN821MA30S	
	2,700	35×45	0.15	4.78	ELXS161VSN272MA45S			1,000	30×40	0.15	2.66	ELXS251VSN102MR40S	
	3,300	35×50	0.15	5.40	ELXS161VSN332MA50S			1,200	30×45	0.15	2.99	ELXS251VSN122MR45S	
	180	390	22×25	0.15	1.34			ELXS181VSN391MP25S	1,200	30×50	0.15	3.04	ELXS251VSN122MR50S
		560	22×30	0.15	1.68			ELXS181VSN561MP30S	1,200	35×35	0.15	3.00	ELXS251VSN122MA35S
		560	25.4×25	0.15	1.67			ELXS181VSN561MQ25S	1,200	35×40	0.15	3.11	ELXS251VSN122MA40S
680		22×35	0.15	1.90	ELXS181VSN681MP35S	1,500		35×45	0.15	3.56	ELXS251VSN152MA45S		
820		22×40	0.15	2.13	ELXS181VSN821MP40S	1,800		35×50	0.15	3.98	ELXS251VSN182MA50S		
820		25.4×30	0.15	2.08	ELXS181VSN821MQ30S	315		180	22×25	0.15	0.95	ELXS311VSN181MP25S	
820		25.4×35	0.15	2.17	ELXS181VSN821MQ35S			220	22×30	0.15	1.10	ELXS311VSN221MP30S	
820		30×25	0.15	2.26	ELXS181VSN821MR25S			220	25.4×25	0.15	1.10	ELXS311VSN221MQ25S	
1,000		22×45	0.15	2.40	ELXS181VSN102MP45S		270	22×35	0.15	1.24	ELXS311VSN271MP35S		
1,000		22×50	0.15	2.45	ELXS181VSN102MP50S		270	25.4×30	0.15	1.25	ELXS311VSN271MQ30S		
1,000		25.4×40	0.15	2.45	ELXS181VSN102MQ40S		330	22×40	0.15	1.40	ELXS311VSN331MP40S		
1,000		30×30	0.15	2.52	ELXS181VSN102MR30S		330	30×25	0.15	1.43	ELXS311VSN331MR25S		
1,000		35×25	0.15	2.66	ELXS181VSN102MA25S		390	22×45	0.15	1.56	ELXS311VSN391MP45S		
1,200		25.4×45	0.15	2.73	ELXS181VSN122MQ45S		390	22×50	0.15	1.59	ELXS311VSN391MP50S		
1,200		30×35	0.15	2.83	ELXS181VSN122MR35S		390	25.4×35	0.15	1.57	ELXS311VSN391MQ35S		
1,500		25.4×50	0.15	3.10	ELXS181VSN152MQ50S		470	25.4×40	0.15	1.76	ELXS311VSN471MQ40S		
1,500		30×40	0.15	3.26	ELXS181VSN152MR40S		470	25.4×45	0.15	1.79	ELXS311VSN471MQ45S		
1,500		35×30	0.15	3.31	ELXS181VSN152MA30S		470	30×30	0.15	1.73	ELXS311VSN471MR30S		
1,800		30×45	0.15	3.66	ELXS181VSN182MR45S		470	35×25	0.15	1.82	ELXS311VSN471MA25S		
1,800		35×35	0.15	3.68	ELXS181VSN182MA35S		560	25.4×50	0.15	1.99	ELXS311VSN561MQ50S		
2,200		30×50	0.15	4.11	ELXS181VSN222MR50S		560	30×35	0.15	1.93	ELXS311VSN561MR35S		
2,200		35×40	0.15	4.22	ELXS181VSN222MA40S		560	35×30	0.15	2.02	ELXS311VSN561MA30S		
2,200		35×45	0.15	4.32	ELXS181VSN222MA45S		680	30×40	0.15	2.19	ELXS311VSN681MA40S		
2,700		35×50	0.15	4.88	ELXS181VSN272MA50S		680	30×45	0.15	2.25	ELXS311VSN681MR45S		
200		390	22×25	0.15	1.34		ELXS201VSN391MP25S	680	35×35	0.15	2.26	ELXS311VSN681MA35S	
		470	22×30	0.15	1.54		ELXS201VSN471MP30S	820	30×50	0.15	2.51	ELXS311VSN821MR50S	
		560	22×35	0.15	1.72		ELXS201VSN561MP35S	820	35×40	0.15	2.57	ELXS311VSN821MA40S	
	560	25.4×25	0.15	1.67	ELXS201VSN561MQ25S		1,000	35×45	0.15	2.91	ELXS311VSN102MA45S		
	680	22×40	0.15	1.94	ELXS201VSN681MP40S		1,200	35×50	0.15	3.25	ELXS311VSN122MA50S		
	680	25.4×30	0.15	1.89	ELXS201VSN681MQ30S		400	120	22×25	0.15	0.77	ELXS401VSN121MP25S	
	680	30×25	0.15	2.06	ELXS201VSN681MR25S			150	22×30	0.15	0.90	ELXS401VSN151MP30S	
	820	22×45	0.15	2.17	ELXS201VSN821MP45S			180	22×35	0.15	1.02	ELXS401VSN181MP35S	
	820	25.4×35	0.15	2.17	ELXS201VSN821MQ35S	180		25.4×25	0.15	0.99	ELXS401VSN181MQ25S		
	1,000	22×50	0.15	2.45	ELXS201VSN102MP50S	220		22×40	0.15	1.15	ELXS401VSN221MP40S		
	1,000	25.4×40	0.15	2.45	ELXS201VSN102MQ40S	220		25.4×30	0.15	1.13	ELXS401VSN221MQ30S		
	1,000	30×30	0.15	2.52	ELXS201VSN102MR30S	220		30×25	0.15	1.17	ELXS401VSN221MR25S		
	1,000	35×25	0.15	2.66	ELXS201VSN102MA25S	270		22×45	0.15	1.29	ELXS401VSN271MP45S		
	1,200	25.4×45	0.15	2.73	ELXS201VSN122MQ45S	270		22×50	0.15	1.32	ELXS401VSN271MP50S		
	1,200	25.4×50	0.15	2.78	ELXS201VSN122MQ50S	270		25.4×35	0.15	1.30	ELXS401VSN271MQ35S		
	1,200	30×35	0.15	2.83	ELXS201VSN122MR35S	330		25.4×40	0.15	1.47	ELXS401VSN331MQ40S		
	1,200	35×30	0.15	2.96	ELXS201VSN122MA30S	330		30×30	0.15	1.45	ELXS401VSN331MR30S		
	1,500	30×40	0.15	3.26	ELXS201VSN152MR40S	330		35×25	0.15	1.52	ELXS401VSN331MA25S		
	1,500	30×45	0.15	3.34	ELXS201VSN152MR45S	390		25.4×45	0.15	1.63	ELXS401VSN391MQ45S		

## ◆STANDARD RATINGS

WV (V <sub>dc</sub> )	Cap (μF)	Case size φD×L(mm)	tanδ	Rated ripple current (Arms/105°C,120Hz)	Part No.	WV (V <sub>dc</sub> )	Cap (μF)	Case size φD×L(mm)	tanδ	Rated ripple current (Arms/105°C,120Hz)	Part No.	
400	390	25.4×50	0.15	1.66	ELXS401VSN391MQ50S	420	390	35×35	0.20	1.71	ELXS421VSN391MA35S	
	390	30×35	0.15	1.61	ELXS401VSN391MR35S		470	30×50	0.20	1.90	ELXS421VSN471MR50S	
	390	35×30	0.15	1.68	ELXS401VSN391MA30S		470	35×40	0.20	1.95	ELXS421VSN471MA40S	
	470	30×40	0.15	1.82	ELXS401VSN471MR40S		560	35×45	0.20	2.17	ELXS421VSN561MA45S	
	470	35×35	0.15	1.88	ELXS401VSN471MA35S		680	35×50	0.20	2.45	ELXS421VSN681MA50S	
	560	30×45	0.15	2.04	ELXS401VSN561MR45S		450	82	22×25	0.20	0.64	ELXS451VSN820MP25S
	560	30×50	0.15	2.07	ELXS401VSN561MR50S			120	22×30	0.20	0.81	ELXS451VSN121MP30S
	560	35×40	0.15	2.13	ELXS401VSN561MA40S			120	22×35	0.20	0.83	ELXS451VSN121MP35S
	680	35×45	0.15	2.40	ELXS401VSN681MA45S			120	25.4×25	0.20	0.81	ELXS451VSN121MQ25S
	820	35×50	0.15	2.69	ELXS401VSN821MA50S			150	22×40	0.20	0.94	ELXS451VSN151MP40S
420	100	22×25	0.20	0.70	ELXS421VSN101MP25S	150		25.4×30	0.20	0.93	ELXS451VSN151MQ30S	
	120	22×30	0.20	0.81	ELXS421VSN121MP30S	180		22×45	0.20	1.06	ELXS451VSN181MP45S	
	120	25.4×25	0.20	0.81	ELXS421VSN121MQ25S	180		25.4×35	0.20	1.06	ELXS451VSN181MQ35S	
	150	22×35	0.20	0.93	ELXS421VSN151MP35S	180		30×25	0.20	1.06	ELXS451VSN181MR25S	
	180	22×40	0.20	1.04	ELXS421VSN181MP40S	220		22×50	0.20	1.20	ELXS451VSN221MP50S	
	180	25.4×30	0.20	1.02	ELXS421VSN181MQ30S	220		25.4×40	0.20	1.20	ELXS451VSN221MQ40S	
	180	30×25	0.20	1.06	ELXS421VSN181MR25S	220		30×30	0.20	1.18	ELXS451VSN221MR30S	
	220	22×45	0.20	1.17	ELXS421VSN221MP45S	220		35×25	0.20	1.24	ELXS451VSN221MA25S	
	220	22×50	0.20	1.20	ELXS421VSN221MP50S	270		25.4×45	0.20	1.36	ELXS451VSN271MQ45S	
	220	25.4×35	0.20	1.18	ELXS421VSN221MQ35S	270		25.4×50	0.20	1.38	ELXS451VSN271MQ50S	
	270	25.4×40	0.20	1.33	ELXS421VSN271MQ40S	270		30×35	0.20	1.34	ELXS451VSN271MR35S	
	270	25.4×45	0.20	1.36	ELXS421VSN271MQ45S	270		35×30	0.20	1.40	ELXS451VSN271MA30S	
	270	30×30	0.20	1.31	ELXS421VSN271MR30S	330		30×40	0.20	1.52	ELXS451VSN331MR40S	
	270	35×25	0.20	1.38	ELXS421VSN271MA25S	390		30×45	0.20	1.70	ELXS451VSN391MR45S	
	330	25.4×50	0.20	1.52	ELXS421VSN331MQ50S	390		30×50	0.20	1.73	ELXS451VSN391MR50S	
	330	30×35	0.20	1.48	ELXS421VSN331MR35S	390	35×35	0.20	1.71	ELXS451VSN391MA35S		
	330	35×30	0.20	1.55	ELXS421VSN331MA30S	470	35×40	0.20	1.95	ELXS451VSN471MA40S		
	390	30×40	0.20	1.66	ELXS421VSN391MR40S	470	35×45	0.20	1.99	ELXS451VSN471MA45S		
	390	30×45	0.20	1.70	ELXS421VSN391MR45S	560	35×50	0.20	2.22	ELXS451VSN561MA50S		

## ◆RATED RIPPLE CURRENT MULTIPLIERS

### ●Frequency Multipliers

Frequency (Hz)	50	120	300	1k	10k	50k
160 to 250V <sub>dc</sub>	0.81	1.00	1.17	1.32	1.45	1.50
315 to 450V <sub>dc</sub>	0.77	1.00	1.16	1.30	1.41	1.43

The endurance of capacitors is reduced with internal heating produced by ripple current at the rate of halving the lifetime with every 5°C rise. When long life performance is required in actual use, the rms ripple current has to be reduced.

# LXQ Series

- Endurance with ripple current : 5,000 hours at 105°C
- Downsized and higher ripple version of LXG series
- Non solvent resistant type
- RoHS Compliant

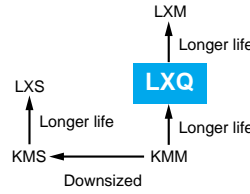

## ◆ SPECIFICATIONS

Items	Characteristics		
Category	Temperature Range		
Temperature Range	-25 to +105°C		
Rated Voltage Range	160 to 450V <sub>dc</sub>		
Capacitance Tolerance	±20% (M) (at 20°C, 120Hz)		
Leakage Current	I ≤ 3√CV Where, I : Max. leakage current (µA), C : Nominal capacitance (µF), V : Rated voltage (V) (at 20°C after 5 minutes)		
Dissipation Factor (tanδ)	Rated voltage (V <sub>dc</sub> )	160 to 400V	420 & 450V
	tanδ (Max.)	0.15	0.20
Low Temperature Characteristics (Max. Impedance Ratio)	Rated voltage (V <sub>dc</sub> )	160 to 400V	420 & 450V
	Z(-25°C)/Z(+20°C)	4	8
Endurance	The following specifications shall be satisfied when the capacitors are restored to 20°C after subjected to DC voltage with the rated ripple current is applied for 5,000 hours at 105°C.		
	Capacitance change	≤ ±20% of the initial value	
	D.F. (tanδ)	≤ 200% of the initial specified value	
	Leakage current	≤ The initial specified value	
Shelf Life	The following specifications shall be satisfied when the capacitors are restored to 20°C after exposing them for 1,000 hours at 105°C without voltage applied.		
	Capacitance change	≤ ±15% of the initial value	
	D.F. (tanδ)	≤ 150% of the initial specified value	
	Leakage current	≤ The initial specified value	

## ◆ DIMENSIONS [mm]

● Terminal Code : VS (φ22 to φ35) : Standard

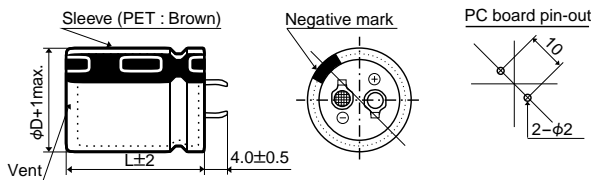

● Terminal Code : LI (φ30, φ35)

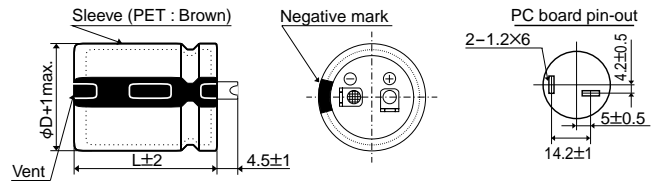

The standard design has no plastic disc.

## ◆ PART NUMBERING SYSTEM

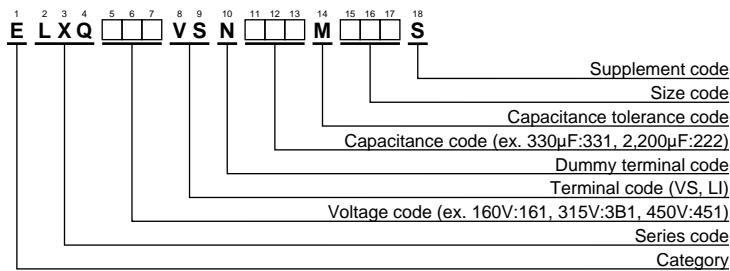

Please refer to "Product code guide (snap-in type)"



### ◆STANDARD RATINGS

WV (Vdc)	Cap (μF)	Case size φD×L(mm)	tanδ	Rated ripple current (Arms/105°C,120Hz)	Part No.	WV (Vdc)	Cap (μF)	Case size φD×L(mm)	tanδ	Rated ripple current (Arms/105°C,120Hz)	Part No.	
160	390	22×25	0.15	1.32	ELXQ161VSN391MP25S	200	1,200	30×50	0.15	2.88	ELXQ201VSN122MR50S	
	560	22×30	0.15	1.66	ELXQ161VSN561MP30S		1,200	35×35	0.15	2.88	ELXQ201VSN122MA35S	
	560	25.4×25	0.15	1.68	ELXQ161VSN561MQ25S		1,500	35×40	0.15	3.34	ELXQ201VSN152MA40S	
	680	22×35	0.15	1.87	ELXQ161VSN681MP35S		1,800	35×45	0.15	3.74	ELXQ201VSN182MA45S	
	680	25.4×30	0.15	1.88	ELXQ161VSN681MQ30S		1,800	35×50	0.15	3.82	ELXQ201VSN182MA50S	
	680	30×25	0.15	1.96	ELXQ161VSN681MR25S		220	270	22×25	0.15	1.10	ELXQ221VSN271MP25S
	820	22×40	0.15	2.09	ELXQ161VSN821MP40S			330	22×30	0.15	1.19	ELXQ221VSN331MP30S
	1,000	22×45	0.15	2.36	ELXQ161VSN102MP45S			390	25.4×25	0.15	1.39	ELXQ221VSN391MQ25S
	1,000	22×50	0.15	2.41	ELXQ161VSN102MP50S			470	22×35	0.15	1.55	ELXQ221VSN471MP35S
	1,000	25.4×35	0.15	2.38	ELXQ161VSN102MQ35S			470	25.4×30	0.15	1.56	ELXQ221VSN471MQ30S
	1,000	30×30	0.15	2.40	ELXQ161VSN102MR30S			470	30×25	0.15	1.63	ELXQ221VSN471MR25S
	1,000	35×25	0.15	2.55	ELXQ161VSN102MA25S			560	22×40	0.15	1.73	ELXQ221VSN561MP40S
	1,200	25.4×40	0.15	2.66	ELXQ161VSN122MQ40S			560	30×30	0.15	1.79	ELXQ221VSN561MR30S
	1,200	25.4×45	0.15	2.71	ELXQ161VSN122MQ45S			680	22×45	0.15	1.94	ELXQ221VSN681MP45S
	1,200	30×35	0.15	2.69	ELXQ161VSN122MR35S			680	22×50	0.15	1.99	ELXQ221VSN681MP50S
	1,200	30×40	0.15	2.77	ELXQ161VSN122MR40S			680	25.4×35	0.15	1.96	ELXQ221VSN681MQ35S
	1,200	35×30	0.15	2.86	ELXQ161VSN122MA30S			680	30×35	0.15	2.02	ELXQ221VSN681MR35S
	1,500	25.4×50	0.15	3.08	ELXQ161VSN152MQ50S			680	35×25	0.15	2.10	ELXQ221VSN681MA25S
	1,500	30×45	0.15	3.17	ELXQ161VSN152MR45S			820	25.4×40	0.15	2.20	ELXQ221VSN821MQ40S
	1,500	35×35	0.15	3.22	ELXQ161VSN152MA35S			820	25.4×45	0.15	2.24	ELXQ221VSN821MQ45S
1,800	30×50	0.15	3.53	ELXQ161VSN182MR50S	820	30×40		0.15	2.29	ELXQ221VSN821MR40S		
1,800	35×40	0.15	3.66	ELXQ161VSN182MA40S	820	35×30		0.15	2.36	ELXQ221VSN821MA30S		
2,200	35×45	0.15	4.14	ELXQ161VSN222MA45S	1,000	25.4×50		0.15	2.51	ELXQ221VSN102MQ50S		
2,700	35×50	0.15	4.68	ELXQ161VSN272MA50S	1,000	30×45		0.15	2.59	ELXQ221VSN102MR45S		
180	330	22×25	0.15	1.21	ELXQ181VSN331MP25S	1,000		35×35	0.15	2.63	ELXQ221VSN102MA35S	
	470	22×30	0.15	1.52	ELXQ181VSN471MP30S	1,200	30×50	0.15	2.88	ELXQ221VSN122MR50S		
	470	25.4×25	0.15	1.52	ELXQ181VSN471MQ25S	1,200	35×40	0.15	2.98	ELXQ221VSN122MA40S		
	560	22×35	0.15	1.70	ELXQ181VSN561MP35S	1,500	35×45	0.15	3.41	ELXQ221VSN152MA45S		
	560	30×25	0.15	1.78	ELXQ181VSN561MR25S	1,800	35×50	0.15	3.82	ELXQ221VSN182MA50S		
	680	22×40	0.15	1.91	ELXQ181VSN681MP40S	250	220	22×25	0.15	1.01	ELXQ251VSN221MP25S	
	680	25.4×30	0.15	1.88	ELXQ181VSN681MQ30S		270	22×30	0.15	1.20	ELXQ251VSN271MP30S	
	820	22×45	0.15	1.99	ELXQ181VSN821MP45S		330	25.4×25	0.15	1.32	ELXQ251VSN331MQ25S	
	820	25.4×35	0.15	2.16	ELXQ181VSN821MQ35S		390	22×35	0.15	1.44	ELXQ251VSN391MP35S	
	820	30×30	0.15	2.17	ELXQ181VSN821MP30S		390	25.4×30	0.15	1.43	ELXQ251VSN391MQ30S	
	820	35×25	0.15	2.31	ELXQ181VSN821MA25S		390	30×25	0.15	1.51	ELXQ251VSN391MR25S	
	1,000	22×50	0.15	2.25	ELXQ181VSN102MP50S		470	22×40	0.15	1.62	ELXQ251VSN471MP40S	
	1,000	25.4×40	0.15	2.43	ELXQ181VSN102MQ40S		560	22×45	0.15	1.80	ELXQ251VSN561MP45S	
	1,000	25.4×45	0.15	2.47	ELXQ181VSN102MQ45S		560	22×50	0.15	1.84	ELXQ251VSN561MP50S	
	1,000	30×35	0.15	2.46	ELXQ181VSN102MR35S		560	25.4×35	0.15	1.78	ELXQ251VSN561MQ35S	
	1,200	25.4×50	0.15	2.75	ELXQ181VSN122MQ50S		560	30×30	0.15	1.83	ELXQ251VSN561MR30S	
	1,200	30×40	0.15	2.77	ELXQ181VSN122MR40S		560	35×25	0.15	1.91	ELXQ251VSN561MA25S	
	1,200	35×30	0.15	2.86	ELXQ181VSN122MA30S		680	25.4×40	0.15	2.00	ELXQ251VSN681MQ40S	
	1,500	30×45	0.15	3.17	ELXQ181VSN152MR45S		680	25.4×45	0.15	2.04	ELXQ251VSN681MQ45S	
	1,500	30×50	0.15	3.22	ELXQ181VSN152MR50S		680	30×35	0.15	2.06	ELXQ251VSN681MR35S	
1,500	35×35	0.15	3.22	ELXQ181VSN152MA35S	680		35×30	0.15	2.15	ELXQ251VSN681MA30S		
1,800	35×40	0.15	3.66	ELXQ181VSN182MA40S	820		25.4×50	0.15	2.28	ELXQ251VSN821MQ50S		
1,800	35×45	0.15	3.74	ELXQ181VSN182MA45S	820		30×40	0.15	2.33	ELXQ251VSN821MR40S		
2,200	35×50	0.15	4.22	ELXQ181VSN222MA50S	820		30×45	0.15	2.39	ELXQ251VSN821MR45S		
200	270	22×25	0.15	1.10	ELXQ201VSN271MP25S		820	35×35	0.15	2.38	ELXQ251VSN821MA35S	
	390	22×30	0.15	1.38	ELXQ201VSN391MP30S	1,000	30×50	0.15	2.68	ELXQ251VSN102MR50S		
	390	25.4×25	0.15	1.39	ELXQ201VSN391MQ25S	1,000	35×40	0.15	2.72	ELXQ251VSN102MA40S		
	470	22×35	0.15	1.55	ELXQ201VSN471MP35S	1,200	35×45	0.15	3.05	ELXQ251VSN122MA45S		
	560	22×40	0.15	1.73	ELXQ201VSN561MP40S	1,500	35×50	0.15	3.49	ELXQ251VSN152MA50S		
	560	25.4×30	0.15	1.71	ELXQ201VSN561MQ30S	315	150	22×25	0.15	0.80	ELXQ3B1VSN151MP25S	
	560	30×25	0.15	1.78	ELXQ201VSN561MR25S		180	22×30	0.15	0.92	ELXQ3B1VSN181MP30S	
	680	22×45	0.15	1.81	ELXQ201VSN681MP45S		180	25.4×25	0.15	0.94	ELXQ3B1VSN181MQ25S	
	680	25.4×35	0.15	1.87	ELXQ201VSN681MQ35S		220	22×35	0.15	1.04	ELXQ3B1VSN221MP35S	
	680	30×30	0.15	1.98	ELXQ201VSN681MR30S		220	30×25	0.15	1.17	ELXQ3B1VSN221MP25S	
	680	35×25	0.15	2.10	ELXQ201VSN681MA25S		270	22×40	0.15	1.18	ELXQ3B1VSN271MP40S	
	820	22×50	0.15	2.18	ELXQ201VSN821MP50S		270	25.4×30	0.15	1.19	ELXQ3B1VSN271MQ30S	
	820	25.4×40	0.15	2.09	ELXQ201VSN821MQ40S		330	22×45	0.15	1.33	ELXQ3B1VSN331MP45S	
	820	30×35	0.15	2.22	ELXQ201VSN821MR35S		330	25.4×35	0.15	1.37	ELXQ3B1VSN331MQ35S	
	1,000	25.4×45	0.15	2.35	ELXQ201VSN102MQ45S		330	30×30	0.15	1.40	ELXQ3B1VSN331MR30S	
	1,000	25.4×50	0.15	2.39	ELXQ201VSN102MQ50S		330	35×25	0.15	1.49	ELXQ3B1VSN331MA25S	
	1,000	30×40	0.15	2.53	ELXQ201VSN102MR40S		390	22×50	0.15	1.48	ELXQ3B1VSN391MP50S	
	1,000	35×30	0.15	2.61	ELXQ201VSN102MA30S		390	25.4×40	0.15	1.52	ELXQ3B1VSN391MQ40S	
	1,200	30×45	0.15	2.84	ELXQ201VSN122MR45S		470	25.4×45	0.15	1.70	ELXQ3B1VSN471MQ45S	



◆STANDARD RATINGS

WV (Vdc)	Cap (μF)	Case size φD×L(mm)	tanδ	Rated ripple current (Arms/105°C,120Hz)	Part No.	WV (Vdc)	Cap (μF)	Case size φD×L(mm)	tanδ	Rated ripple current (Arms/105°C,120Hz)	Part No.	
315	470	30×35	0.15	1.71	ELXQ3B1VSN471MR35S	400	470	30×45	0.15	1.81	ELXQ401VSN471MR45S	
	470	35×30	0.15	1.82	ELXQ3B1VSN471MA30S		470	30×50	0.15	1.84	ELXQ401VSN471MR50S	
	560	25.4×50	0.15	1.88	ELXQ3B1VSN561MQ50S		470	35×40	0.15	1.90	ELXQ401VSN471MA40S	
	560	30×40	0.15	1.92	ELXQ3B1VSN561MR40S		560	35×45	0.15	2.12	ELXQ401VSN561MA45S	
	560	30×45	0.15	1.97	ELXQ3B1VSN561MR45S		680	35×50	0.15	2.39	ELXQ401VSN681MA50S	
	560	35×35	0.15	2.00	ELXQ3B1VSN561MA35S		420	100	22×25	0.20	0.66	ELXQ421VSN101MP25S
	680	30×50	0.15	2.21	ELXQ3B1VSN681MR50S			120	22×30	0.20	0.75	ELXQ421VSN121MP30S
	680	35×40	0.15	2.29	ELXQ3B1VSN681MA40S			120	25.4×25	0.20	0.77	ELXQ421VSN121MQ25S
	820	35×45	0.15	2.57	ELXQ3B1VSN821MA45S			150	22×35	0.20	0.86	ELXQ421VSN151MP35S
	1,000	35×50	0.15	2.89	ELXQ3B1VSN102MA50S			180	22×40	0.20	0.96	ELXQ421VSN181MP40S
350	120	22×25	0.15	0.72	ELXQ351VSN121MP25S	180		22×45	0.20	0.98	ELXQ421VSN181MP45S	
	150	22×30	0.15	0.84	ELXQ351VSN151MP30S	180		25.4×30	0.20	0.97	ELXQ421VSN181MQ30S	
	180	25.4×25	0.15	0.94	ELXQ351VSN181MQ25S	180		25.4×35	0.20	1.01	ELXQ421VSN181MQ35S	
	220	22×35	0.15	1.04	ELXQ351VSN221MP35S	180		30×25	0.20	1.02	ELXQ421VSN181MR25S	
	220	22×40	0.15	1.06	ELXQ351VSN221MP40S	220		22×50	0.20	1.11	ELXQ421VSN221MP50S	
	220	25.4×30	0.15	1.07	ELXQ351VSN221MQ30S	220		25.4×40	0.20	1.14	ELXQ421VSN221MQ40S	
	220	30×25	0.15	1.13	ELXQ351VSN221MR25S	220		30×30	0.20	1.14	ELXQ421VSN221MR30S	
	270	22×45	0.15	1.20	ELXQ351VSN271MP45S	220		35×25	0.20	1.22	ELXQ421VSN221MA25S	
	270	25.4×35	0.15	1.24	ELXQ351VSN271MQ35S	270		25.4×45	0.20	1.29	ELXQ421VSN271MQ45S	
	270	30×30	0.15	1.27	ELXQ351VSN271MR30S	270		30×35	0.20	1.30	ELXQ421VSN271MR35S	
	270	35×25	0.15	1.35	ELXQ351VSN271MA25S	270		35×30	0.20	1.38	ELXQ421VSN271MA30S	
	330	22×50	0.15	1.36	ELXQ351VSN331MP50S	330		25.4×50	0.20	1.44	ELXQ421VSN331MQ50S	
	330	25.4×40	0.15	1.39	ELXQ351VSN331MQ40S	330		30×40	0.20	1.48	ELXQ421VSN331MR40S	
	330	30×35	0.15	1.43	ELXQ351VSN331MR35S	330		35×35	0.20	1.54	ELXQ421VSN331MA35S	
	390	25.4×45	0.15	1.55	ELXQ351VSN391MQ45S	390		30×45	0.20	1.64	ELXQ421VSN391MR45S	
	390	30×40	0.15	1.60	ELXQ351VSN391MR40S	390	35×40	0.20	1.73	ELXQ421VSN391MA40S		
	390	35×30	0.15	1.66	ELXQ351VSN391MA30S	470	30×50	0.20	1.84	ELXQ421VSN471MR50S		
	470	25.4×50	0.15	1.72	ELXQ351VSN471MQ50S	470	35×45	0.20	1.94	ELXQ421VSN471MA45S		
	470	30×45	0.15	1.81	ELXQ351VSN471MR45S	560	35×50	0.20	2.17	ELXQ421VSN561MA50S		
	470	35×35	0.15	1.83	ELXQ351VSN471MA35S	450	82	22×25	0.20	0.59	ELXQ451VSN820MP25S	
560	30×50	0.15	2.00	ELXQ351VSN561MR50S	100		22×30	0.20	0.69	ELXQ451VSN101MP30S		
560	35×40	0.15	2.07	ELXQ351VSN561MA40S	100		25.4×25	0.20	0.70	ELXQ451VSN101MQ25S		
680	35×45	0.15	2.34	ELXQ351VSN681MA45S	120		22×35	0.20	0.77	ELXQ451VSN121MP35S		
820	35×50	0.15	2.62	ELXQ351VSN821MA50S	150		22×40	0.20	0.88	ELXQ451VSN151MP40S		
400	100	22×25	0.15	0.66	ELXQ401VSN101MP25S		150	22×45	0.20	0.90	ELXQ451VSN151MP45S	
	120	22×30	0.15	0.75	ELXQ401VSN121MP30S		150	25.4×30	0.20	0.88	ELXQ451VSN151MQ30S	
	150	22×35	0.15	0.86	ELXQ401VSN151MP35S		150	25.4×35	0.20	0.92	ELXQ451VSN151MQ35S	
	150	25.4×25	0.15	0.86	ELXQ401VSN151MQ25S		150	30×25	0.20	0.93	ELXQ451VSN151MR25S	
	180	22×40	0.15	0.96	ELXQ401VSN181MP40S		180	22×50	0.20	1.01	ELXQ451VSN181MP50S	
	180	25.4×30	0.15	0.97	ELXQ401VSN181MQ30S		180	25.4×40	0.20	1.03	ELXQ451VSN181MQ40S	
	180	30×25	0.15	1.02	ELXQ401VSN181MR25S		180	30×30	0.20	1.03	ELXQ451VSN181MR30S	
	220	22×45	0.15	1.09	ELXQ401VSN221MP45S		180	35×25	0.20	1.10	ELXQ451VSN181MA25S	
	220	25.4×35	0.15	1.12	ELXQ401VSN221MQ35S		220	25.4×45	0.20	1.16	ELXQ451VSN221MQ45S	
	220	35×25	0.15	1.22	ELXQ401VSN221MA25S		220	30×35	0.20	1.17	ELXQ451VSN221MR35S	
	270	22×50	0.15	1.23	ELXQ401VSN271MP50S		220	35×30	0.20	1.24	ELXQ451VSN221MA30S	
	270	25.4×40	0.15	1.26	ELXQ401VSN271MQ40S		270	25.4×50	0.20	1.31	ELXQ451VSN271MQ50S	
	270	25.4×45	0.15	1.29	ELXQ401VSN271MQ45S		270	30×40	0.20	1.33	ELXQ451VSN271MR40S	
	270	30×30	0.15	1.27	ELXQ401VSN271MR30S		270	35×35	0.20	1.39	ELXQ451VSN271MA35S	
	330	25.4×50	0.15	1.44	ELXQ401VSN331MQ50S		330	30×45	0.20	1.51	ELXQ451VSN331MR45S	
	330	30×35	0.15	1.43	ELXQ401VSN331MR35S	390	30×50	0.20	1.67	ELXQ451VSN391MR50S		
	330	35×30	0.15	1.52	ELXQ401VSN331MA30S	390	35×40	0.20	1.73	ELXQ451VSN391MA40S		
	390	30×40	0.15	1.60	ELXQ401VSN391MR40S	390	35×45	0.20	1.77	ELXQ451VSN391MA45S		
	390	35×35	0.15	1.67	ELXQ401VSN391MA35S	470	35×50	0.20	1.98	ELXQ451VSN471MA50S		

◆RATED RIPPLE CURRENT MULTIPLIERS

●Frequency Multipliers

Frequency (Hz)	50	120	300	1k	10k	50k
160 to 250V <sub>dc</sub>	0.81	1.00	1.17	1.32	1.45	1.50
315 to 450V <sub>dc</sub>	0.77	1.00	1.16	1.30	1.41	1.43

The endurance of capacitors is reduced with internal heating produced by ripple current at the rate of halving the lifetime with every 5°C rise. When long life performance is required in actual use, the rms ripple current has to be reduced.

# LXG Series

- Endurance with ripple current : 5,000 hours at 105°C
- Non solvent resistant type
- RoHS Compliant

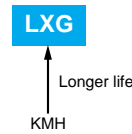

## ◆SPECIFICATIONS

Items	Characteristics
Category	
Temperature Range	-40 to +105°C
Rated Voltage Range	10 to 100V <sub>dc</sub> (at 20°C, 120Hz)
Capacitance Tolerance	±20% (M)
Leakage Current	I=0.02CV or 3mA, whichever is smaller. Where, I : Max. leakage current (µA), C : Nominal capacitance (µF), V : Rated voltage (V) (at 20°C after 5 minutes)
Dissipation Factor (tanδ)	Rated voltage (V <sub>dc</sub> ) 10V 16V 25V 35V 50V 63V 80 & 100V tanδ (Max.) 0.60 0.45 0.30 0.25 0.20 0.15 0.15 (at 20°C, 120Hz)
Low Temperature Characteristics (Max. Impedance Ratio)	Capacitance change : Capacitance at the lowest operating temperature shall not be less than 70% of the 20°C value. Rated voltage (V <sub>dc</sub> ) 10V 16V 25V 35V 50V 63V 80 & 100V Z(-25°C)/Z(+20°C) 4 4 3 3 2 2 2 Z(-40°C)/Z(+20°C) 15 15 10 8 6 6 5 (at 120Hz)
Endurance	The following specifications shall be satisfied when the capacitors are restored to 20°C after subjected to DC voltage with rated ripple current is applied for 5,000 hours at 105°C. Capacitance change ≤±25% of the initial value D.F. (tanδ) ≤250% of the initial specified value Leakage current ≤The initial specified value
Shelf Life	The following specifications shall be satisfied when the capacitors are restored to 20°C after exposing them for 500 hours at 105°C without voltage applied. Capacitance change ≤±20% of the initial value D.F. (tanδ) ≤150% of the initial specified value Leakage current ≤The initial specified value

## ◆DIMENSIONS [mm]

- Terminal Code : VS (φ22 to φ35) : Standard

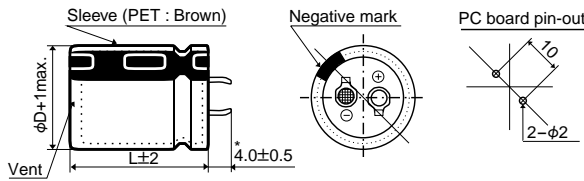

\*φD=35mm : 3.5±0.5mm

The standard design has no plastic disc.

- Terminal Code : LI (φ35)

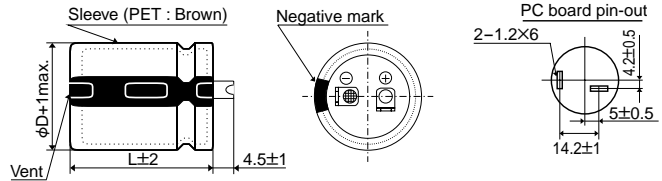

## ◆PART NUMBERING SYSTEM

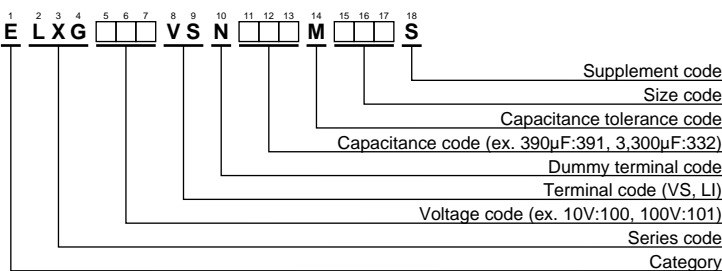

Please refer to "Product code guide (snap-in type)"

## ◆RATED RIPPLE CURRENT MULTIPLIERS

- Frequency Multipliers

Frequency (Hz)	50	120	300	1k	10k	50k
10 to 50V <sub>dc</sub>	0.95	1.00	1.03	1.05	1.08	1.08
63 to 100V <sub>dc</sub>	0.92	1.00	1.07	1.13	1.19	1.20

The endurance of capacitors is reduced with internal heating produced by ripple current at the rate of halving the lifetime with every 5°C rise. When long life performance is required in actual use, the rms ripple current has to be reduced.





### ◆STANDARD RATINGS

WV (Vdc)	Cap (μF)	Case size φD×L(mm)	tanδ	Rated ripple current (Arms/105°C,120Hz)	Part No.	WV (Vdc)	Cap (μF)	Case size φD×L(mm)	tanδ	Rated ripple current (Arms/105°C,120Hz)	Part No.
10	6,800	22×25	0.60	1.30	ELXG100VSN682MP25S	35	5,600	25.4×35	0.25	1.98	ELXG350VSN562MQ35S
	10,000	22×30	0.60	1.65	ELXG100VSN103MP30S		5,600	30×30	0.25	1.98	ELXG350VSN562MR30S
	10,000	25.4×25	0.60	1.64	ELXG100VSN103MQ25S		5,600	35×25	0.25	2.03	ELXG350VSN562MA25S
	12,000	22×35	0.60	1.85	ELXG100VSN123MP35S		6,800	22×50	0.25	2.26	ELXG350VSN682MP50S
	12,000	25.4×30	0.60	1.85	ELXG100VSN123MQ30S		6,800	25.4×40	0.25	2.24	ELXG350VSN682MQ40S
	12,000	30×25	0.60	1.89	ELXG100VSN123MR25S		8,200	25.4×50	0.25	2.57	ELXG350VSN822MQ50S
	15,000	22×40	0.60	2.12	ELXG100VSN153MP40S		8,200	30×35	0.25	2.50	ELXG350VSN822MR35S
	15,000	25.4×35	0.60	2.16	ELXG100VSN153MQ35S		8,200	35×30	0.25	2.55	ELXG350VSN822MA30S
	18,000	22×50	0.60	2.45	ELXG100VSN183MP50S		10,000	30×40	0.25	2.86	ELXG350VSN103MR40S
	18,000	25.4×40	0.60	2.43	ELXG100VSN183MQ40S		10,000	35×35	0.25	2.88	ELXG350VSN103MA35S
	18,000	30×30	0.60	2.37	ELXG100VSN183MR30S		12,000	30×50	0.25	3.32	ELXG350VSN123MR50S
	18,000	35×25	0.60	2.42	ELXG100VSN183MA25S		12,000	35×40	0.25	3.30	ELXG350VSN123MA40S
	22,000	30×35	0.60	2.73	ELXG100VSN223MR35S		18,000	35×50	0.25	4.29	ELXG350VSN183MA50S
	22,000	35×30	0.60	2.79	ELXG100VSN223MA30S		1,500	22×25	0.20	1.02	ELXG500VSN102MP25S
	27,000	25.4×50	0.60	3.11	ELXG100VSN273MQ50S		1,800	22×30	0.20	1.17	ELXG500VSN182MP30S
	27,000	30×40	0.60	3.13	ELXG100VSN273MR40S		1,800	25.4×25	0.20	1.17	ELXG500VSN182MQ25S
	33,000	35×35	0.60	3.49	ELXG100VSN333MA35S		2,200	22×35	0.20	1.33	ELXG500VSN222MP35S
	39,000	30×50	0.60	3.99	ELXG100VSN393MR50S		2,700	22×40	0.20	1.51	ELXG500VSN272MP40S
	39,000	35×40	0.60	3.96	ELXG100VSN393MA40S		2,700	25.4×30	0.20	1.47	ELXG500VSN272MQ30S
	47,000	35×50	0.60	4.62	ELXG100VSN473MA50S		2,700	30×25	0.20	1.50	ELXG500VSN272MR25S
16	5,600	22×25	0.45	1.44	ELXG160VSN562MP25S	3,300	25.4×35	0.20	1.70	ELXG500VSN332MQ35S	
	6,800	22×30	0.45	1.66	ELXG160VSN682MP30S	3,300	30×30	0.20	1.70	ELXG500VSN332MR30S	
	6,800	25.4×25	0.45	1.66	ELXG160VSN682MQ25S	3,300	35×25	0.20	1.74	ELXG500VSN332MA25S	
	8,200	22×35	0.45	1.87	ELXG160VSN822MP35S	3,900	22×50	0.20	1.91	ELXG500VSN392MP50S	
	10,000	22×40	0.45	2.12	ELXG160VSN103MP40S	3,900	25.4×40	0.20	1.89	ELXG500VSN392MQ40S	
	10,000	25.4×30	0.45	2.07	ELXG160VSN103MQ30S	4,700	30×35	0.20	2.11	ELXG500VSN472MR35S	
	10,000	30×25	0.45	2.11	ELXG160VSN103MR25S	4,700	35×30	0.20	2.16	ELXG500VSN472MA30S	
	12,000	25.4×35	0.45	2.37	ELXG160VSN123MQ35S	5,600	25.4×50	0.20	2.38	ELXG500VSN562MQ50S	
	12,000	30×30	0.45	2.37	ELXG160VSN123MR30S	5,600	30×40	0.20	2.39	ELXG500VSN562MR40S	
	12,000	35×25	0.45	2.42	ELXG160VSN123MA25S	5,600	35×35	0.20	2.41	ELXG500VSN562MA35S	
	15,000	22×50	0.45	2.74	ELXG160VSN153MP50S	6,800	30×50	0.20	2.79	ELXG500VSN682MR50S	
	15,000	25.4×40	0.45	2.71	ELXG160VSN153MQ40S	6,800	35×40	0.20	2.78	ELXG500VSN682MA40S	
	18,000	25.4×50	0.45	3.11	ELXG160VSN183MQ50S	10,000	35×50	0.20	3.57	ELXG500VSN103MA50S	
	18,000	30×35	0.45	3.02	ELXG160VSN183MR35S	1,000	22×25	0.15	1.00	ELXG630VSN102MP25S	
	18,000	35×30	0.45	3.09	ELXG160VSN183MA30S	1,200	22×30	0.15	1.15	ELXG630VSN122MP30S	
	22,000	30×40	0.45	3.46	ELXG160VSN223MR40S	1,200	25.4×25	0.15	1.15	ELXG630VSN122MQ25S	
	22,000	35×35	0.45	3.49	ELXG160VSN223MA35S	1,500	22×35	0.15	1.32	ELXG630VSN152MP35S	
	27,000	30×50	0.45	4.07	ELXG160VSN273MR50S	1,800	22×40	0.15	1.49	ELXG630VSN182MP40S	
	27,000	35×40	0.45	4.04	ELXG160VSN273MA40S	1,800	25.4×30	0.15	1.45	ELXG630VSN182MQ30S	
	39,000	35×50	0.45	5.16	ELXG160VSN393MA50S	1,800	30×25	0.15	1.48	ELXG630VSN182MR25S	
25	3,900	22×25	0.30	1.31	ELXG250VSN392MP25S	2,200	25.4×35	0.15	1.67	ELXG630VSN222MQ35S	
	4,700	22×30	0.30	1.51	ELXG250VSN472MP30S	2,200	30×30	0.15	1.68	ELXG630VSN222MR30S	
	4,700	25.4×25	0.30	1.51	ELXG250VSN472MQ25S	2,200	35×25	0.15	1.71	ELXG630VSN222MA25S	
	5,600	22×35	0.30	1.70	ELXG250VSN562MP35S	2,700	22×50	0.15	1.92	ELXG630VSN272MP50S	
	6,800	22×40	0.30	1.92	ELXG250VSN682MP40S	2,700	25.4×40	0.15	1.90	ELXG630VSN272MQ40S	
	6,800	25.4×30	0.30	1.87	ELXG250VSN682MQ30S	2,700	30×35	0.15	1.93	ELXG630VSN272MR35S	
	6,800	30×25	0.30	1.90	ELXG250VSN682MR25S	3,300	25.4×50	0.15	2.20	ELXG630VSN332MQ50S	
	8,200	25.4×35	0.30	2.14	ELXG250VSN822MQ35S	3,300	35×30	0.15	2.18	ELXG630VSN332MA30S	
	8,200	30×30	0.30	2.15	ELXG250VSN822MR30S	3,900	30×40	0.15	2.41	ELXG630VSN392MR40S	
	8,200	35×25	0.30	2.19	ELXG250VSN822MA25S	3,900	35×35	0.15	2.43	ELXG630VSN392MA35S	
	10,000	22×50	0.30	2.45	ELXG250VSN103MP50S	4,700	30×50	0.15	2.80	ELXG630VSN472MR50S	
	10,000	25.4×40	0.30	2.43	ELXG250VSN103MQ40S	4,700	35×40	0.15	2.78	ELXG630VSN472MA40S	
	12,000	25.4×50	0.30	2.78	ELXG250VSN123MQ50S	6,800	35×50	0.15	3.55	ELXG630VSN682MA50S	
	12,000	30×35	0.30	2.70	ELXG250VSN123MR35S	680	22×25	0.15	0.97	ELXG800VSN681MP25S	
	12,000	35×30	0.30	2.76	ELXG250VSN123MA30S	820	22×30	0.15	1.12	ELXG800VSN821MP30S	
	15,000	30×40	0.30	3.13	ELXG250VSN153MR40S	1,000	22×35	0.15	1.27	ELXG800VSN102MP35S	
	15,000	35×35	0.30	3.16	ELXG250VSN153MA35S	1,000	25.4×25	0.15	1.23	ELXG800VSN102MQ25S	
	18,000	30×50	0.30	3.64	ELXG250VSN183MR50S	1,200	22×40	0.15	1.42	ELXG800VSN122MP40S	
	18,000	35×40	0.30	3.61	ELXG250VSN183MA40S	1,200	25.4×30	0.15	1.39	ELXG800VSN122MQ30S	
	27,000	35×50	0.30	4.70	ELXG250VSN273MA50S	1,200	30×25	0.15	1.41	ELXG800VSN122MR25S	
35	2,200	22×25	0.25	1.10	ELXG350VSN222MP25S	1,500	25.4×35	0.15	1.62	ELXG800VSN152MP35S	
	3,300	22×30	0.25	1.42	ELXG350VSN332MP30S	1,800	22×50	0.15	1.84	ELXG800VSN182MP50S	
	3,300	25.4×25	0.25	1.41	ELXG350VSN332MQ25S	1,800	25.4×40	0.15	1.82	ELXG800VSN182MQ40S	
	3,900	22×35	0.25	1.58	ELXG350VSN392MP35S	1,800	30×30	0.15	1.78	ELXG800VSN182MR30S	
	3,900	25.4×30	0.25	1.58	ELXG350VSN392MQ30S	1,800	35×25	0.15	1.82	ELXG800VSN182MA25S	
	4,700	22×40	0.25	1.78	ELXG350VSN472MP40S	2,200	25.4×50	0.15	2.11	ELXG800VSN222MQ50S	
	4,700	30×25	0.25	1.77	ELXG350VSN472MR25S	2,200	30×35	0.15	2.05	ELXG800VSN222MR35S	

◆STANDARD RATINGS

WV (Vdc)	Cap (μF)	Case size φD×L(mm)	tanδ	Rated ripple current (Arms/105°C,120Hz)	Part No.	WV (Vdc)	Cap (μF)	Case size φD×L(mm)	tanδ	Rated ripple current (Arms/105°C,120Hz)	Part No.
80	2,200	35×30	0.15	2.09	ELXG800VSN222MA30S	100	1,000	25.4×35	0.15	1.41	ELXG101VSN102MQ35S
	2,700	30×40	0.15	2.35	ELXG800VSN272MR40S		1,000	30×30	0.15	1.42	ELXG101VSN102MR30S
	2,700	35×35	0.15	2.37	ELXG800VSN272MA35S		1,000	35×25	0.15	1.45	ELXG101VSN102MA25S
	3,300	30×50	0.15	2.75	ELXG800VSN332MR50S		1,200	22×50	0.15	1.60	ELXG101VSN122MP50S
	3,300	35×40	0.15	2.73	ELXG800VSN332MA40S		1,200	25.4×40	0.15	1.59	ELXG101VSN122MQ40S
	4,700	35×50	0.15	3.46	ELXG800VSN472MA50S		1,200	30×35	0.15	1.61	ELXG101VSN122MR35S
100	390	22×25	0.15	0.78	ELXG101VSN391MP25S		1,500	25.4×50	0.15	1.86	ELXG101VSN152MQ50S
	560	22×30	0.15	0.99	ELXG101VSN561MP30S		1,500	30×40	0.15	1.87	ELXG101VSN152MR40S
	560	25.4×25	0.15	0.98	ELXG101VSN561MQ25S		1,500	35×30	0.15	1.85	ELXG101VSN152MA30S
	680	22×35	0.15	1.12	ELXG101VSN681MP35S		1,800	35×35	0.15	2.07	ELXG101VSN182MA35S
	820	22×40	0.15	1.26	ELXG101VSN821MP40S		2,200	30×50	0.15	2.40	ELXG101VSN222MR50S
	820	25.4×30	0.15	1.23	ELXG101VSN821MQ30S		2,200	35×40	0.15	2.39	ELXG101VSN222MA40S
	820	30×25	0.15	1.25	ELXG101VSN821MR25S		2,700	35×50	0.15	2.81	ELXG101VSN272MA50S

◆MAXIMUM IMPEDANCE [mΩ/20°C, 30kHz]

Case size φD×L (mm)	V <sub>dc</sub>		
	10 to 63	80	100
22×25	120	150	
22×30	100	120	
22×35	80	95	
22×40	70	80	
22×50	50	60	
25.4×25	90	110	
25.4×30	70	85	
25.4×35	60	70	
25.4×40	50	60	
25.4×50	40	45	
30×25	70	80	
30×30	50	60	
30×35	40	50	
30×40	35	40	
30×50	25	30	
35×25	65	70	
35×30	45	50	
35×35	38	40	
35×40	30	30	
35×50	23	25	

●105°C Endurance with Rated Ripple Current

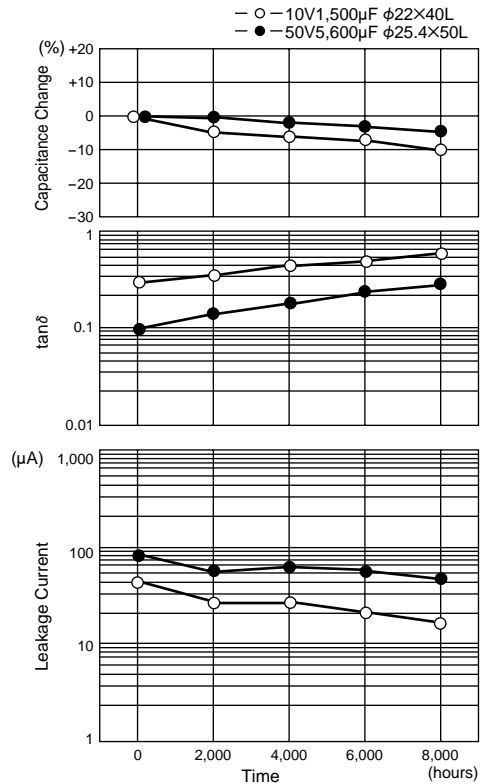

Upgrade!

# CHA Series

- Doesn't spark with DC over voltage
- Downsized from current KLG series
- Endurance with ripple current : 2,000hours at 105°C
- Non solvent resistant type
- RoHS Compliant

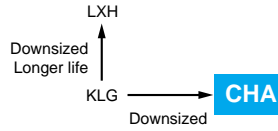

## ◆ SPECIFICATIONS

Items	Characteristics	
Category	-25 to +105°C	
Temperature Range	-25 to +105°C	
Rated Voltage Range	200 to 450V <sub>dc</sub>	
Capacitance Tolerance	±20% (M) (at 20°C, 120Hz)	
Leakage Current	I ≤ 3√CV (at 20°C after 5 minutes) Where, I : Max. leakage current (µA), C : Nominal capacitance (µF), V : Rated voltage (V <sub>dc</sub> )	
Dissipation Factor (tanδ)	200V <sub>dc</sub> : 0.15 max. (0.20 max. for φD=35mm) 400V <sub>dc</sub> : 0.15 max. (at 20°C, 120Hz)	
Low Temperature Characteristics (Max.Impedance Ratio)	Rated Voltage (V <sub>dc</sub> )	200 to 450V
	Z(-25°C) / Z(+20°C)	4 (at 120Hz)
ESL	50nH max. (at 20°C, 1MHz)	
Endurance	The following specifications shall be satisfied when the capacitors are restored to 20°C after subjected to DC voltage with the rated ripple current is applied for 2,000 hours at 105°C.	
	Capacitance change	≤ ±20% of the initial value
	D.F. (tanδ)	≤ 200% of the initial specified value
	Leakage current	≤ The initial specified value
Shelf Life	The following specifications shall be satisfied when the capacitors are restored to 20°C after exposing them for 1,000 hours at 105°C without voltage applied.	
	Capacitance change	≤ ±15% of the initial value
	D.F. (tanδ)	≤ 150% of the initial specified value
	Leakage current	≤ The initial specified value

## ◆ DIMENSIONS [mm]

- Terminal Code : VS (φ22 to φ35)

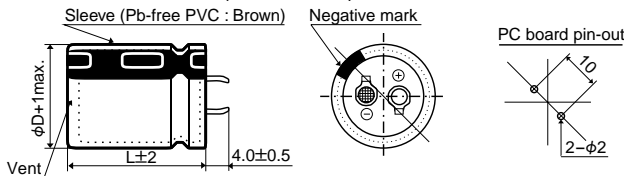

The standard design has no plastic disc.

## ◆ PART NUMBERING SYSTEM

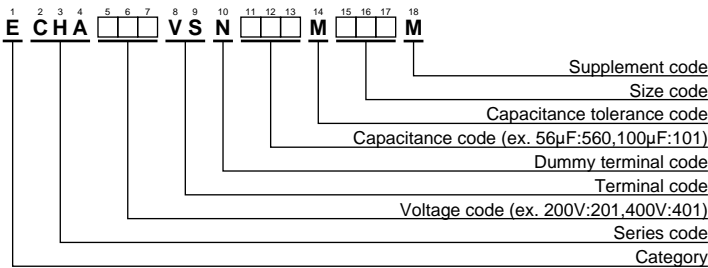

Please refer to "Product code guide (snap-in type)"

## ◆ RATED RIPPLE CURRENT MULTIPLIERS

- Frequency Multipliers

Frequency (Hz)	50	120	300	1k	10k	50k
200 to 450V <sub>dc</sub>	0.77	1.00	1.16	1.30	1.41	1.43

The endurance of capacitors is reduced with internal heating produced by ripple current at the rate of halving the lifetime with every 5°C rise. When long life performance is required in actual use, the rms ripple current has to be reduced.

◆STANDARD RATINGS

WV (V <sub>dc</sub> )	Cap (μF)	Case size φD×L(mm)	tanδ	Rated ripple current (A <sub>rms</sub> /105°C,120Hz)	Part No.	WV (V <sub>dc</sub> )	Cap (μF)	Case size φD×L(mm)	tanδ	Rated ripple current (A <sub>rms</sub> /105°C,120Hz)	Part No.	
200	180	22×20	0.15	0.82	ECHA201VSN181MP20M	250	390	35×20	0.20	1.62	ECHA251VSN391MA20M	
	220	22×20	0.15	0.90	ECHA201VSN221MP20M		470	25.4×40	0.15	1.64	ECHA251VSN471MQ40M	
	270	22×25	0.15	1.02	ECHA201VSN271MP25M		470	30×30	0.15	1.67	ECHA251VSN471MR30M	
	330	22×30	0.15	1.20	ECHA201VSN331MP30M		560	25.4×45	0.15	1.82	ECHA251VSN561MQ45M	
	330	25.4×25	0.15	1.20	ECHA201VSN331MQ25M		560	30×35	0.15	1.87	ECHA251VSN561MR35M	
	390	22×30	0.15	1.35	ECHA201VSN391MP30M		560	35×25	0.20	1.99	ECHA251VSN561MA25M	
	390	25.4×25	0.15	1.35	ECHA201VSN391MQ25M		680	30×40	0.15	2.12	ECHA251VSN681MR40M	
	470	22×35	0.15	1.45	ECHA201VSN471MP35M		680	35×30	0.20	2.19	ECHA251VSN681MA30M	
	470	25.4×30	0.15	1.45	ECHA201VSN471MQ30M		820	30×45	0.15	2.39	ECHA251VSN821MR45M	
	470	30×25	0.15	1.47	ECHA201VSN471MR25M		820	35×35	0.20	2.42	ECHA251VSN821MA35M	
	560	22×40	0.15	1.62	ECHA201VSN561MP40M		400	56	22×20	0.15	0.45	ECHA401VSN560MP20M
	560	25.4×30	0.15	1.60	ECHA201VSN561MQ30M			68	22×20	0.15	0.51	ECHA401VSN680MP20M
	560	30×25	0.15	1.60	ECHA201VSN561MR25M			82	22×25	0.15	0.58	ECHA401VSN820MP25M
	680	25.4×35	0.15	1.82	ECHA201VSN681MQ35M			100	22×25	0.15	0.66	ECHA401VSN101MP25M
	680	30×30	0.15	1.81	ECHA201VSN681MR30M			100	25.4×25	0.15	0.66	ECHA401VSN101MQ25M
	680	35×25	0.20	1.86	ECHA201VSN681MA25M			120	22×30	0.15	0.76	ECHA401VSN121MP30M
	820	25.4×45	0.15	2.11	ECHA201VSN821MQ45M			120	25.4×25	0.15	0.76	ECHA401VSN121MQ25M
	820	30×35	0.15	2.11	ECHA201VSN821MR35M			150	22×35	0.15	0.85	ECHA401VSN151MP35M
	820	35×25	0.20	2.11	ECHA201VSN821MA25M			150	25.4×30	0.15	0.85	ECHA401VSN151MQ30M
	1,000	30×35	0.15	2.40	ECHA201VSN102MR35M			150	30×25	0.15	0.85	ECHA401VSN151MR25M
1,000	35×30	0.20	2.40	ECHA201VSN102MA30M	180	22×40		0.15	0.94	ECHA401VSN181MP40M		
1,200	30×45	0.15	2.69	ECHA201VSN122MR45M	180	25.4×35		0.15	0.95	ECHA401VSN181MQ35M		
1,200	35×35	0.20	2.65	ECHA201VSN122MA35M	180	30×25		0.15	0.95	ECHA401VSN181MR25M		
250	120	22×20	0.15	0.68	ECHA251VSN121MP20M	220		25.4×35	0.15	1.24	ECHA401VSN221MQ35M	
	180	22×25	0.15	0.87	ECHA251VSN181MP25M	220		30×30	0.15	1.24	ECHA401VSN221MR30M	
	180	25.4×20	0.15	0.93	ECHA251VSN181MQ20M	220		35×25	0.15	1.24	ECHA401VSN221MA25M	
	220	22×30	0.15	1.00	ECHA251VSN221MP30M	270		25.4×45	0.15	1.30	ECHA401VSN271MQ45M	
	270	22×35	0.15	1.14	ECHA251VSN271MP35M	270		30×35	0.15	1.30	ECHA401VSN271MR35M	
	270	25.4×25	0.15	1.13	ECHA251VSN271MQ25M	270		35×25	0.15	1.30	ECHA401VSN271MA25M	
	270	30×20	0.15	1.25	ECHA251VSN271MR20M	330		30×40	0.15	1.47	ECHA401VSN331MR40M	
	330	22×40	0.15	1.28	ECHA251VSN331MP40M	330	35×30	0.15	1.47	ECHA401VSN331MA30M		
	330	25.4×30	0.15	1.29	ECHA251VSN331MQ30M	450	180	30×35	0.20	1.00	ECHA451VSN181MR35M	
	390	22×45	0.15	1.42	ECHA251VSN391MP45M		220	30×40	0.20	1.20	ECHA451VSN221MR40M	
	390	25.4×35	0.15	1.46	ECHA251VSN391MQ35M		390	35×40	0.20	1.60	ECHA451VSN391MA40M	
	390	30×25	0.15	1.52	ECHA251VSN391MR25M							

◆DC OVERVOLTAGE TEST CONDITIONS

The vent will operate and the capacitor shall become an open circuit without burning materials when the following test DC voltage is applied.

●Test DC voltage

Rated Voltage	Nominal Capacitance	Current Limit	Test Voltage
200V <sub>dc</sub>	<330	4A	300/375V <sub>dc</sub>
	330μF ≤ C < 470μF	5A	
	≥ 470μF	7A	
250V <sub>dc</sub>	<330μF	4A	350/450V <sub>dc</sub>
	330μF ≤ C < 470μF	5A	
	≥ 470μF	7A	
400V <sub>dc</sub>	<100μF	2A	500/600V <sub>dc</sub>
	100μF ≤ C < 220μF	4A	
	≥ 220μF	7A	
450V <sub>dc</sub>	<100μF	2A	550/675V <sub>dc</sub>
	100μF ≤ C < 220μF	4A	
	≥ 220μF	7A	

●Test Circuit

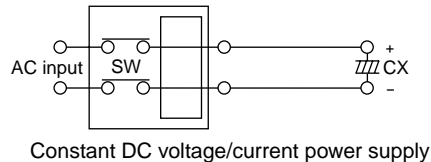

# LXH Series

- Doesn't spark with DC over voltage
- Same case sizes of KMH
- Endurance with ripple current : 5,000 hours at 105°C
- Non solvent resistant type
- RoHS Compliant

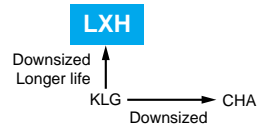

## ◆ SPECIFICATIONS

Items	Characteristics	
Category		
Temperature Range	-25 to +105°C	
Rated Voltage	200 & 400V <sub>dc</sub>	
Capacitance Tolerance	±20% (M) (at 20°C, 120Hz)	
Leakage Current	I=0.02CV or 3mA, whichever is smaller. Where, I : Max. leakage current (µA), C : Nominal capacitance (µF), V : Rated voltage (V) (at 20°C after 5 minutes)	
Dissipation Factor (tanδ)	0.15 max. (at 20°C, 120Hz)	
Low Temperature Characteristics	Z(-25°C) / Z(+20°C) ≤ 4 (at 120Hz)	
ESL	50nH max. (at 20°C, 1MHz)	
DC Overvoltage Test	When an excessive DC voltage is applied to the capacitors under the test conditions on next page, the vent shall operate and then the capacitors shall become open-circuit without burning materials.	
Endurance	The following specifications shall be satisfied when the capacitors are restored to 20°C after subjected to DC voltage with the rated ripple current is applied for 3,000 or 5,000 hours at 105°C.	
	Capacitance change	≤ ±20% of the initial value
	D.F. (tanδ)	≤ 200% of the initial specified value
Shelf Life	The following specifications shall be satisfied when the capacitors are restored to 20°C after exposing them for 1,000 hours at 105°C without voltage applied.	
	Capacitance change	≤ ±15% of the initial value
	D.F. (tanδ)	≤ 150% of the initial specified value
	Leakage current	≤ The initial specified value

## ◆ DIMENSIONS [mm]

- Terminal Code : VS (φ22 to φ35)

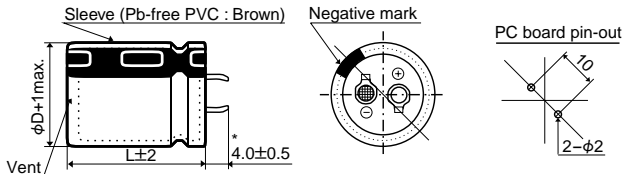

\*φD=35mm : 3.5±0.5mm

The standard design has no plastic disc.

## ◆ PART NUMBERING SYSTEM

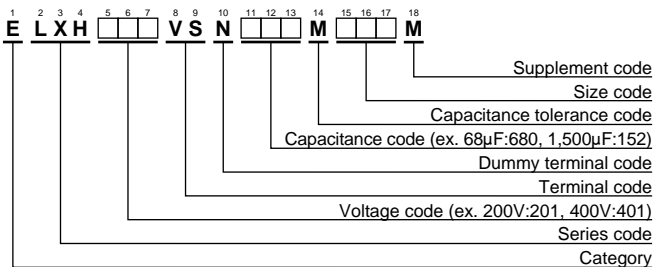

Please refer to "Product code guide (snap-in type)"

## ◆ RATED RIPPLE CURRENT MULTIPLIERS

- Frequency Multipliers

Frequency (Hz)	50	120	300	1k	10k	50k
200V <sub>dc</sub>	0.81	1.00	1.17	1.32	1.45	1.50
400V <sub>dc</sub>	0.77	1.00	1.16	1.30	1.41	1.43

The endurance of capacitors is reduced with internal heating produced by ripple current at the rate of halving the lifetime with every 5°C rise.

When long life performance is required in actual use, the rms ripple current has to be reduced.

## ● 105°C Endurance with Rated Ripple Current

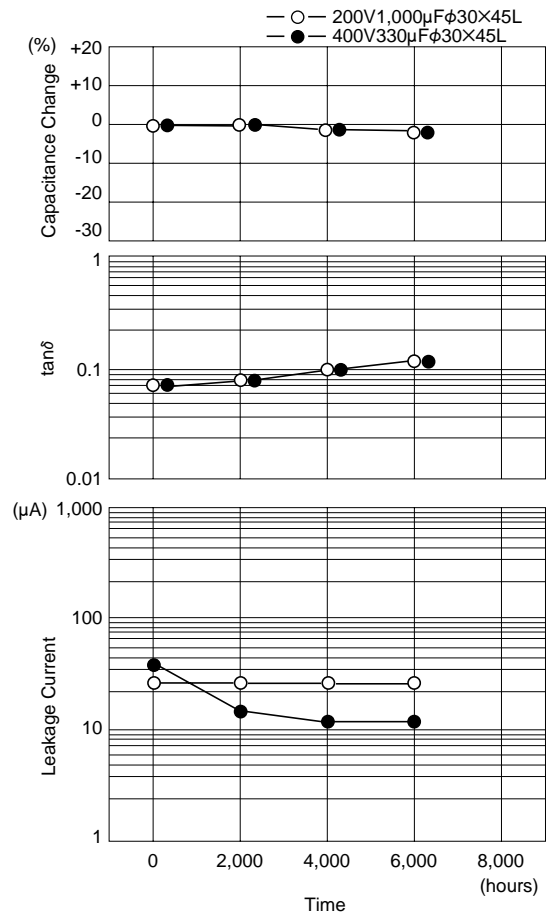

◆STANDARD RATINGS

WV (Vdc)	Cap (μF)	Case size φD×L(mm)	tanδ	Rated ripple current (Arms/105°C,120Hz)		Part No.
				5,000 hours	3,000 hours	
200	270	22×25	0.15	0.45	0.87	ELXH201VSN271MP25M
	330	22×30	0.15	0.62	1.20	ELXH201VSN331MP30M
	330	25.4×25	0.15	0.62	1.21	ELXH201VSN331MQ25M
	390	22×35	0.15	0.67	1.31	ELXH201VSN391MP35M
	390	25.4×30	0.15	0.66	1.28	ELXH201VSN391MQ30M
	470	22×40	0.15	0.72	1.40	ELXH201VSN471MP40M
	470	25.4×30	0.15	0.72	1.41	ELXH201VSN471MQ30M
	470	30×25	0.15	0.77	1.50	ELXH201VSN471MR25M
	560	22×45	0.15	0.80	1.56	ELXH201VSN561MP45M
	560	25.4×35	0.15	0.78	1.53	ELXH201VSN561MQ35M
	560	30×30	0.15	0.81	1.57	ELXH201VSN561MR30M
	680	22×50	0.15	0.89	1.74	ELXH201VSN681MP50M
	680	25.4×40	0.15	0.89	1.74	ELXH201VSN681MQ40M
	680	30×30	0.15	0.89	1.74	ELXH201VSN681MR30M
	680	35×25	0.15	0.88	1.72	ELXH201VSN681MA25M
	820	25.4×50	0.15	1.05	2.04	ELXH201VSN821MQ50M
	820	30×35	0.15	1.03	2.00	ELXH201VSN821MR35M
	820	35×30	0.15	1.05	2.04	ELXH201VSN821MA30M
	1,000	30×45	0.15	1.18	2.30	ELXH201VSN102MR45M
	1,000	35×35	0.15	1.18	2.30	ELXH201VSN102MA35M
1,200	30×50	0.15	1.33	2.60	ELXH201VSN122MR50M	
1,200	35×40	0.15	1.36	2.65	ELXH201VSN122MA40M	
1,500	35×45	0.15	1.57	3.08	ELXH201VSN152MA45M	
400	68	22×25	0.15	0.26	0.51	ELXH401VSN680MP25M
	68	25.4×20	0.15	0.24	0.46	ELXH401VSN680MQ20M
	82	22×30	0.15	0.30	0.58	ELXH401VSN820MP30M
	82	25.4×25	0.15	0.30	0.58	ELXH401VSN820MQ25M
	100	22×35	0.15	0.34	0.66	ELXH401VSN101MP35M
	100	25.4×30	0.15	0.34	0.66	ELXH401VSN101MQ30M
	120	22×40	0.15	0.37	0.72	ELXH401VSN121MP40M
	120	25.4×30	0.15	0.37	0.72	ELXH401VSN121MQ30M
	120	30×25	0.15	0.39	0.76	ELXH401VSN121MR25M
	150	22×45	0.15	0.42	0.82	ELXH401VSN151MP45M
	150	25.4×35	0.15	0.43	0.84	ELXH401VSN151MQ35M
	150	30×30	0.15	0.43	0.84	ELXH401VSN151MR30M
	180	22×50	0.15	0.49	0.95	ELXH401VSN181MP50M
	180	25.4×40	0.15	0.48	0.94	ELXH401VSN181MQ40M
	180	30×30	0.15	0.47	0.92	ELXH401VSN181MR30M
	180	35×25	0.15	0.48	0.94	ELXH401VSN181MA25M
	220	25.4×45	0.15	0.55	1.07	ELXH401VSN221MQ45M
	220	30×35	0.15	0.54	1.06	ELXH401VSN221MR35M
	220	35×30	0.15	0.55	1.08	ELXH401VSN221MA30M
	270	25.4×50	0.15	0.62	1.21	ELXH401VSN271MQ50M
	270	30×40	0.15	0.62	1.21	ELXH401VSN271MR40M
	270	35×30	0.15	0.59	1.15	ELXH401VSN271MA30M
	330	30×45	0.15	0.71	1.39	ELXH401VSN331MR45M
	330	35×35	0.15	0.69	1.35	ELXH401VSN331MA35M
	390	30×50	0.15	0.80	1.55	ELXH401VSN391MR50M
390	35×40	0.15	0.79	1.54	ELXH401VSN391MA40M	
470	35×45	0.15	0.89	1.74	ELXH401VSN471MA45M	

◆DC OVERVOLTAGE TEST CONDITIONS

The vent will operate and the capacitor shall become an open circuit without burning materials when the following test DC voltage is applied.

●Test DC voltage

Rated Voltage	Capacitance	Current limit	Test DC voltage
200V <sub>dc</sub>	<330μF	4A	300/375V <sub>dc</sub>
	330≤C<470μF	5A	
	≥470μF	7A	
400V <sub>dc</sub>	<100μF	2A	500/600V <sub>dc</sub>
	100≤C<220μF	4A	
	≥220μF	7A	

●Test Circuit

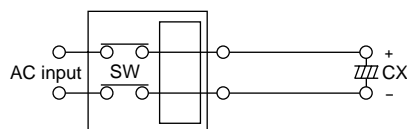

Constant DC voltage/current power supply

## Appendix (Global code)

### ◆Capacitance code

\* How to use the table

	1st
2nd	Cap. Value

Capacitance value part

2nd	1st								
	1	2	3	4	5	6	7	8	9
0	10.0	20.0	30.0	40.0	50.0	60.0	70.0	80.0	90.0
A	10.5	20.5	30.5	40.5	50.5	60.5	70.5	80.5	90.5
1	11.0	21.0	31.0	41.0	51.0	61.0	71.0	81.0	91.0
B	11.5	21.5	31.5	41.5	51.5	61.5	71.5	81.5	91.5
2	12.0	22.0	32.0	42.0	52.0	62.0	72.0	82.0	92.0
C	12.5	22.5	32.5	42.5	52.5	62.5	72.5	82.5	92.5
3	13.0	23.0	33.0	43.0	53.0	63.0	73.0	83.0	93.0
D	13.5	23.5	33.5	43.5	53.5	63.5	73.5	83.5	93.5
4	14.0	24.0	34.0	44.0	54.0	64.0	74.0	84.0	94.0
E	14.5	24.5	34.5	44.5	54.5	64.5	74.5	84.5	94.5
5	15.0	25.0	35.0	45.0	55.0	65.0	75.0	85.0	95.0
F	15.5	25.5	35.5	45.5	55.5	65.5	75.5	85.5	95.5
6	16.0	26.0	36.0	46.0	56.0	66.0	76.0	86.0	96.0
G	16.5	26.5	36.5	46.5	56.5	66.5	76.5	86.5	96.5
7	17.0	27.0	37.0	47.0	57.0	67.0	77.0	87.0	97.0
H	17.5	27.5	37.5	47.5	57.5	67.5	77.5	87.5	97.5
8	18.0	28.0	38.0	48.0	58.0	68.0	78.0	88.0	98.0
J	18.5	28.5	38.5	48.5	58.5	68.5	78.5	88.5	98.5
9	19.0	29.0	39.0	49.0	59.0	69.0	79.0	89.0	99.0
K	19.5	29.5	39.5	49.5	59.5	69.5	79.5	89.5	99.5

For less than 10 $\mu$ F, a decimal point position is displayed with R.

For 10 $\mu$ F or more, capacitance code is set to the first 2 digits and index (1 digit).

Treatment of fraction (Refer to the table)

Example of conversion

Real cap.	The first 2 digits	Treatment of fraction	Code		
			11th	12th	13th
10.0 $\mu$ F →	10.0 →	10.0 →	1	0	0
10.1 $\mu$ F →	10.1 →	10.0 →	1	0	0
10.2 $\mu$ F →	10.2 →	10.0 →	1	0	0
10.3 $\mu$ F →	10.3 →	10.5 →	1	A	0
10.4 $\mu$ F →	10.4 →	10.5 →	1	A	0
10.5 $\mu$ F →	10.5 →	10.5 →	1	A	0
10.6 $\mu$ F →	10.6 →	10.5 →	1	A	0
10.7 $\mu$ F →	10.7 →	10.5 →	1	A	0
10.8 $\mu$ F →	10.8 →	11.0 →	1	1	0
10.9 $\mu$ F →	10.9 →	11.0 →	1	1	0
11.0 $\mu$ F →	11.0 →	11.0 →	1	1	0
132 $\mu$ F →	13.2 →	13.0 →	1	3	1
133 $\mu$ F →	13.3 →	13.5 →	1	D	1
167 $\mu$ F →	16.7 →	16.5 →	1	G	1
168 $\mu$ F →	16.8 →	17.0 →	1	7	1
1110 $\mu$ F →	11.1 →	11.0 →	1	1	2
1340 $\mu$ F →	13.4 →	13.5 →	1	D	2
13200 $\mu$ F →	13.2 →	13.0 →	1	3	3
13600 $\mu$ F →	13.6 →	13.5 →	1	D	3
270000 $\mu$ F →	27.0 →	27.0 →	2	7	4

### ◆Case length (Radial lead type)

Case length [mm]	16th	17th
0.0	—	—
0.1	0	B
0.2	0	C
0.3	0	D
0.4	0	E
0.5	0	F
0.6	0	G
0.7	0	H
0.8	0	J
0.9	0	K

Case length [mm]	16th	17th
1.0	0	1
1.1	1	B
1.2	1	C
1.3	1	D
1.4	1	E
1.5	1	F
1.6	1	G
1.7	1	H
1.8	1	J
1.9	1	K

Case length [mm]	16th	17th
2.0	0	2
2.1	2	B
2.2	2	C
2.3	2	D
2.4	2	E
2.5	2	F
2.6	2	G
2.7	2	H
2.8	2	J
2.9	2	K

Case length [mm]	16th	17th
3.0	0	3
3.1	3	B
3.2	3	C
3.3	3	D
3.4	3	E
3.5	3	F
3.6	3	G
3.7	3	H
3.8	3	J
3.9	3	K

Case length [mm]	16th	17th
4.0	0	4
4.1	4	B
4.2	4	C
4.3	4	D
4.4	4	E
4.5	4	F
4.6	4	G
4.7	4	H
4.8	4	J
4.9	4	K

Case length [mm]	16th	17th
5.0	0	5
5.1	5	B
5.2	5	C
5.3	5	D
5.4	5	E
5.5	5	F
5.6	5	G
5.7	5	H
5.8	5	J
5.9	5	K

Case length [mm]	16th	17th
6.0	0	6
6.1	6	B
6.2	6	C
6.3	6	D
6.4	6	E
6.5	6	F
6.6	6	G
6.7	6	H
6.8	6	J
6.9	6	K

Case length [mm]	16th	17th
7.0	0	7
7.1	7	B
7.2	7	C
7.3	7	D
7.4	7	E
7.5	7	F
7.6	7	G
7.7	7	H
7.8	7	J
7.9	7	K

Case length [mm]	16th	17th
8.0	0	8
8.1	8	B
8.2	8	C
8.3	8	D
8.4	8	E
8.5	8	F
8.6	8	G
8.7	8	H
8.8	8	J
8.9	8	K

Case length [mm]	16th	17th
9.0	0	9
9.1	9	B
9.2	9	C
9.3	9	D
9.4	9	E
9.5	9	F
9.6	9	G
9.7	9	H
9.8	9	J
9.9	9	K

Case length [mm]	16th	17th
10.0	1	0
10.1	A	1
10.2	A	2
10.3	A	3
10.4	A	4
10.5	A	5
10.6	A	6
10.7	A	7
10.8	A	8
10.9	A	9

Case length [mm]	16th	17th
11.0	1	1
11.1	B	1
11.2	B	2
11.3	B	3
11.4	B	4
11.5	B	5
11.6	B	6
11.7	B	7
11.8	B	8
11.9	B	9

Case length [mm]	16th	17th
12.0	1	2
12.1	C	1
12.2	C	2
12.3	C	3
12.4	C	4
12.5	C	5
12.6	C	6
12.7	C	7
12.8	C	8
12.9	C	9

Case length [mm]	16th	17th
13.0	1	3
13.1	D	1
13.2	D	2
13.3	D	3
13.4	D	4
13.5	D	5
13.6	D	6
13.7	D	7
13.8	D	8
13.9	D	9

Case length [mm]	16th	17th
14.0	1	4
14.1	E	1
14.2	E	2
14.3	E	3
14.4	E	4
14.5	E	5
14.6	E	6
14.7	E	7
14.8	E	8
14.9	E	9



# PART NUMBERING SYSTEM

Case length [mm]	16th	17th
15.0	1	5
15.1	F	1
15.2	F	2
15.3	F	3
15.4	F	4
15.5	F	5
15.6	F	6
15.7	F	7
15.8	F	8
15.9	F	9

Case length [mm]	16th	17th
16.0	1	6
16.1	G	1
16.2	G	2
16.3	G	3
16.4	G	4
16.5	G	5
16.6	G	6
16.7	G	7
16.8	G	8
16.9	G	9

Case length [mm]	16th	17th
17.0	1	7
17.1	H	1
17.2	H	2
17.3	H	3
17.4	H	4
17.5	H	5
17.6	H	6
17.7	H	7
17.8	H	8
17.9	H	9

Case length [mm]	16th	17th
18.0	1	8
18.1	J	1
18.2	J	2
18.3	J	3
18.4	J	4
18.5	J	5
18.6	J	6
18.7	J	7
18.8	J	8
18.9	J	9

Case length [mm]	16th	17th
19.0	1	9
19.1	K	1
19.2	K	2
19.3	K	3
19.4	K	4
19.5	K	5
19.6	K	6
19.7	K	7
19.8	K	8
19.9	K	9

Case length [mm]	16th	17th
20.0	2	0
20.5	L	1
21.0	2	1
21.5	L	3
22.0	2	2
22.5	L	5
23.0	2	3
23.5	L	7
24.0	2	4
24.5	L	9
25.0	2	5
25.5	M	1
26.0	2	6
26.5	M	3
27.0	2	7
27.5	M	5
28.0	2	8
28.5	M	7
29.0	2	9
29.5	M	9

Case length [mm]	16th	17th
30.0	3	0
30.5	N	1
31.0	3	1
31.5	N	3
32.0	3	2
32.5	N	5
33.0	3	3
33.5	N	7
34.0	3	4
34.5	N	9
35.0	3	5
35.5	P	1
36.0	3	6
36.5	P	3
37.0	3	7
37.5	P	5
38.0	3	8
38.5	P	7
39.0	3	9
39.5	P	9

Case length [mm]	16th	17th
40.0	4	0
40.5	Q	1
41.0	4	1
41.5	Q	3
42.0	4	2
42.5	Q	5
43.0	4	3
43.5	Q	7
44.0	4	4
44.5	Q	9
45.0	4	5
45.5	R	1
46.0	4	6
46.5	R	3
47.0	4	7
47.5	R	5
48.0	4	8
48.5	R	7
49.0	4	9
49.5	R	9

Case length [mm]	16th	17th
50.0	5	0
50.5	S	1
51.0	5	1
51.5	S	3
52.0	5	2
52.5	S	5
53.0	5	3
53.5	S	7
54.0	5	4
54.5	S	9
55.0	5	5
55.5	T	1
56.0	5	6
56.5	T	3
57.0	5	7
57.5	T	5
58.0	5	8
58.5	T	7
59.0	5	9
59.5	T	9

Case length [mm]	16th	17th
60.0	6	0
60.5	U	1
61.0	6	1
61.5	U	3
62.0	6	2
62.5	U	5
63.0	6	3
63.5	U	7
64.0	6	4
64.5	U	9
65.0	6	5
65.5	V	1
66.0	6	6
66.5	V	3
67.0	6	7
67.5	V	5
68.0	6	8
68.5	V	7
69.0	6	9
69.5	V	9

Case length [mm]	16th	17th
70.0	7	0
70.5	W	1
71.0	7	1
71.5	W	3
72.0	7	2
72.5	W	5
73.0	7	3
73.5	W	7
74.0	7	4
74.5	W	9
75.0	7	5
75.5	X	1
76.0	7	6
76.5	X	3
77.0	7	7
77.5	X	5
78.0	7	8
78.5	X	7
79.0	7	9
79.5	X	9

Case length [mm]	16th	17th
80.0	8	0
80.5	Y	1
81.0	8	1
81.5	Y	3
82.0	8	2
82.5	Y	5
83.0	8	3
83.5	Y	7
84.0	8	4
84.5	Y	9
85.0	8	5
85.5	Z	1
86.0	8	6
86.5	Z	3
87.0	8	7
87.5	Z	5
88.0	8	8
88.5	Z	7
89.0	8	9
89.5	Z	9



## ◆Case length (Snap-in type / Screw mount terminal type)

Case length [mm]	16th	17th	Case length [mm]	16th	17th	Case length [mm]	16th	17th	Case length [mm]	16th	17th	Case length [mm]	16th	17th
20	2	0	30	3	0	40	4	0	50	5	0	60	6	0
21	2	1	31	3	1	41	4	1	51	5	1	61	6	1
22	2	2	32	3	2	42	4	2	52	5	2	62	6	2
23	2	3	33	3	3	43	4	3	53	5	3	63	6	3
24	2	4	34	3	4	44	4	4	54	5	4	64	6	4
25	2	5	35	3	5	45	4	5	55	5	5	65	6	5
26	2	6	36	3	6	46	4	6	56	5	6	66	6	6
27	2	7	37	3	7	47	4	7	57	5	7	67	6	7
28	2	8	38	3	8	48	4	8	58	5	8	68	6	8
29	2	9	39	3	9	49	4	9	59	5	9	69	6	9
70	7	0	80	8	0	90	9	0	100	A	0	110	B	0
71	7	1	81	8	1	91	9	1	101	A	1	111	B	1
72	7	2	82	8	2	92	9	2	102	A	2	112	B	2
73	7	3	83	8	3	93	9	3	103	A	3	113	B	3
74	7	4	84	8	4	94	9	4	104	A	4	114	B	4
75	7	5	85	8	5	95	9	5	105	A	5	115	B	5
76	7	6	86	8	6	96	9	6	106	A	6	116	B	6
77	7	7	87	8	7	97	9	7	107	A	7	117	B	7
78	7	8	88	8	8	98	9	8	108	A	8	118	B	8
79	7	9	89	8	9	99	9	9	109	A	9	119	B	9
120	C	0	130	D	0	140	E	0	150	F	0	160	G	0
121	C	1	131	D	1	141	E	1	151	F	1	161	G	1
122	C	2	132	D	2	142	E	2	152	F	2	162	G	2
123	C	3	133	D	3	143	E	3	153	F	3	163	G	3
124	C	4	134	D	4	144	E	4	154	F	4	164	G	4
125	C	5	135	D	5	145	E	5	155	F	5	165	G	5
126	C	6	136	D	6	146	E	6	156	F	6	166	G	6
127	C	7	137	D	7	147	E	7	157	F	7	167	G	7
128	C	8	138	D	8	148	E	8	158	F	8	168	G	8
129	C	9	139	D	9	149	E	9	159	F	9	169	G	9
170	H	0	180	J	0	190	K	0	200	L	0	210	M	0
171	H	1	181	J	1	191	K	1	201	L	1	211	M	1
172	H	2	182	J	2	192	K	2	202	L	2	212	M	2
173	H	3	183	J	3	193	K	3	203	L	3	213	M	3
174	H	4	184	J	4	194	K	4	204	L	4	214	M	4
175	H	5	185	J	5	195	K	5	205	L	5	215	M	5
176	H	6	186	J	6	196	K	6	206	L	6	216	M	6
177	H	7	187	J	7	197	K	7	207	L	7	217	M	7
178	H	8	188	J	8	198	K	8	208	L	8	218	M	8
179	H	9	189	J	9	199	K	9	209	L	9	219	M	9
220	N	0	230	P	0	240	Q	0	250	R	0			
221	N	1	231	P	1	241	Q	1	251	R	1			
222	N	2	232	P	2	242	Q	2	252	R	2			
223	N	3	233	P	3	243	Q	3	253	R	3			
224	N	4	234	P	4	244	Q	4	254	R	4			
225	N	5	235	P	5	245	Q	5	255	R	5			
226	N	6	236	P	6	246	Q	6	256	R	6			
227	N	7	237	P	7	247	Q	7	257	R	7			
228	N	8	238	P	8	248	Q	8	258	R	8			
229	N	9	239	P	9	249	Q	9	259	R	9			

## ◆ Supplement code

### Surface mount type / Conductive polymer (Include Radial lead type)

	Terminal plating material (Radial lead type)		
	Sn100%	Sn-Bi	Sn-Pb
Coating case	S	G	N

### Radial lead type / Snap-in type

		Terminal plating material (Radial lead type)		
		Sn100%	Sn-Bi	Sn-Pb
Outer sleeve	PET	S	D	C
	Coating case	H	G	F
	Polyolefin	L	—	—
	Pb-free PVC	M	—	N
	PVC	B	A	N

\* Pb-free snap-in type does not have a top disc.

We also produce Pb-free snap-in type with "Top disk, Pb-free PVC sleeve and Sn100% terminal plating".

In this case, supplement code (the 18th digit) is "T".

### Screw mount terminal type

	Screw terminal
Pb-free PVC	M
Polyolefin	S
PET	C
PVC	N